

AC001

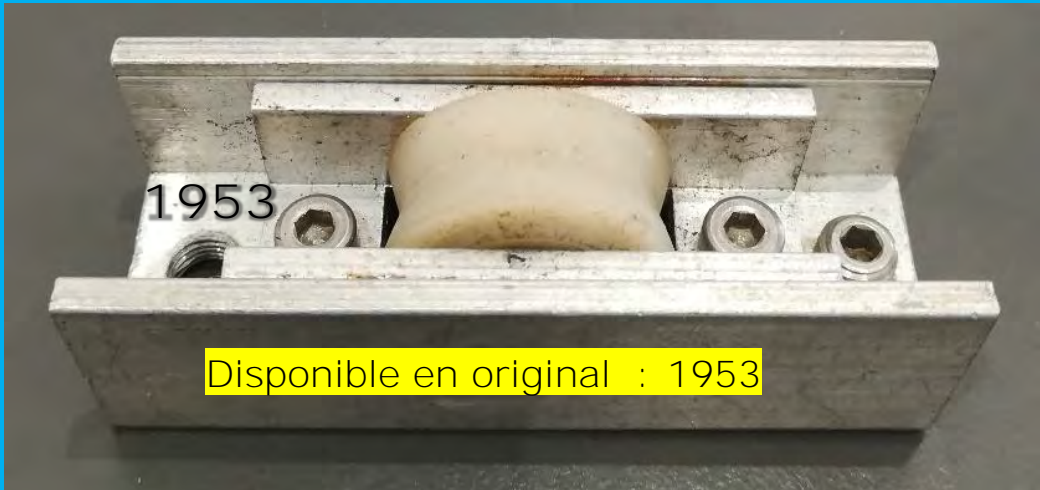

Disponible en original : 1953

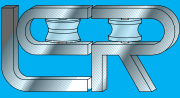
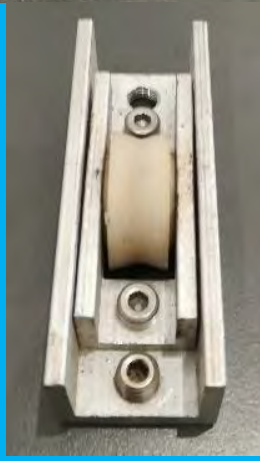

AC002

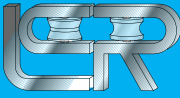

1958



1958

1953



AC003

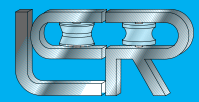

✓TECHNAL 1952



AC004

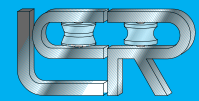

✓TECHNAL 1950



AC005

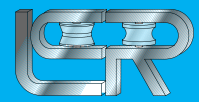

✓TECHNAL 1957



AC006

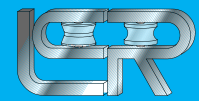

✓TECHNAL 2952



AC007



AC008

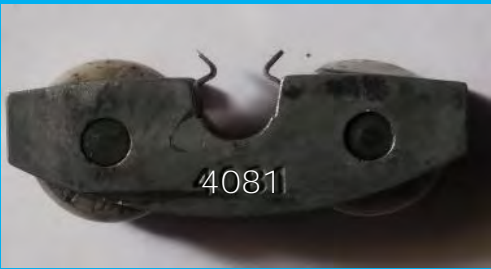
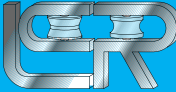

AC009

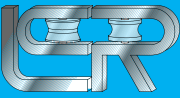

FAPIM

SEPALUMIC

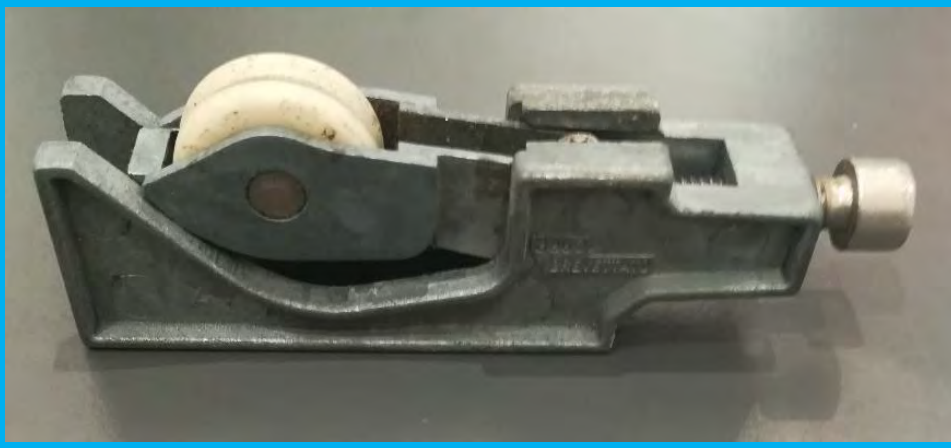

≠ DIMENSIONS

AC010

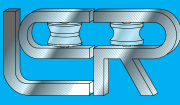

ACO11

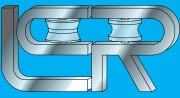

Code Chariot : 3413A simple
: 3414A double

ACO12

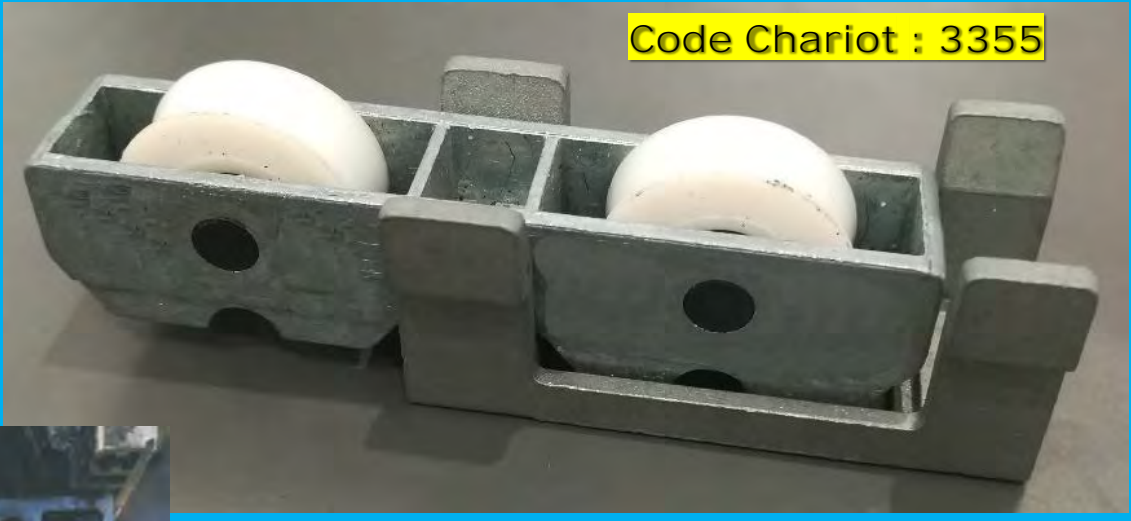
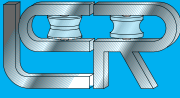

Code Chariot : 3355



ACO13

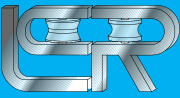

ACO14

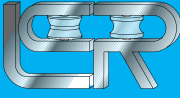

AC015

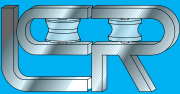

AC016

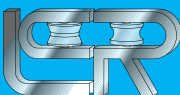

AC017

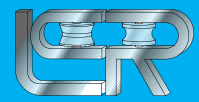

✓ARC03

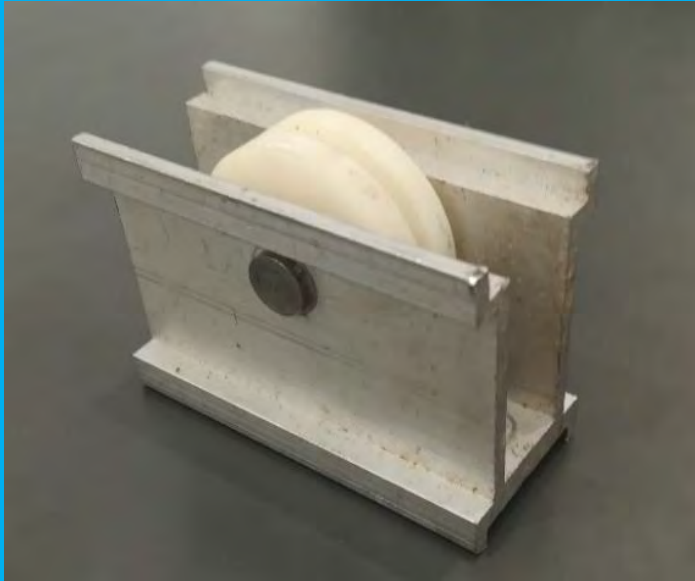

AC018

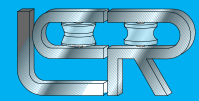

✓ARC04



AC019

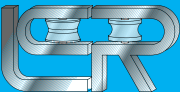

✓ARC02



AC020

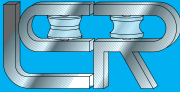

Anciens ALUVAR



AC021

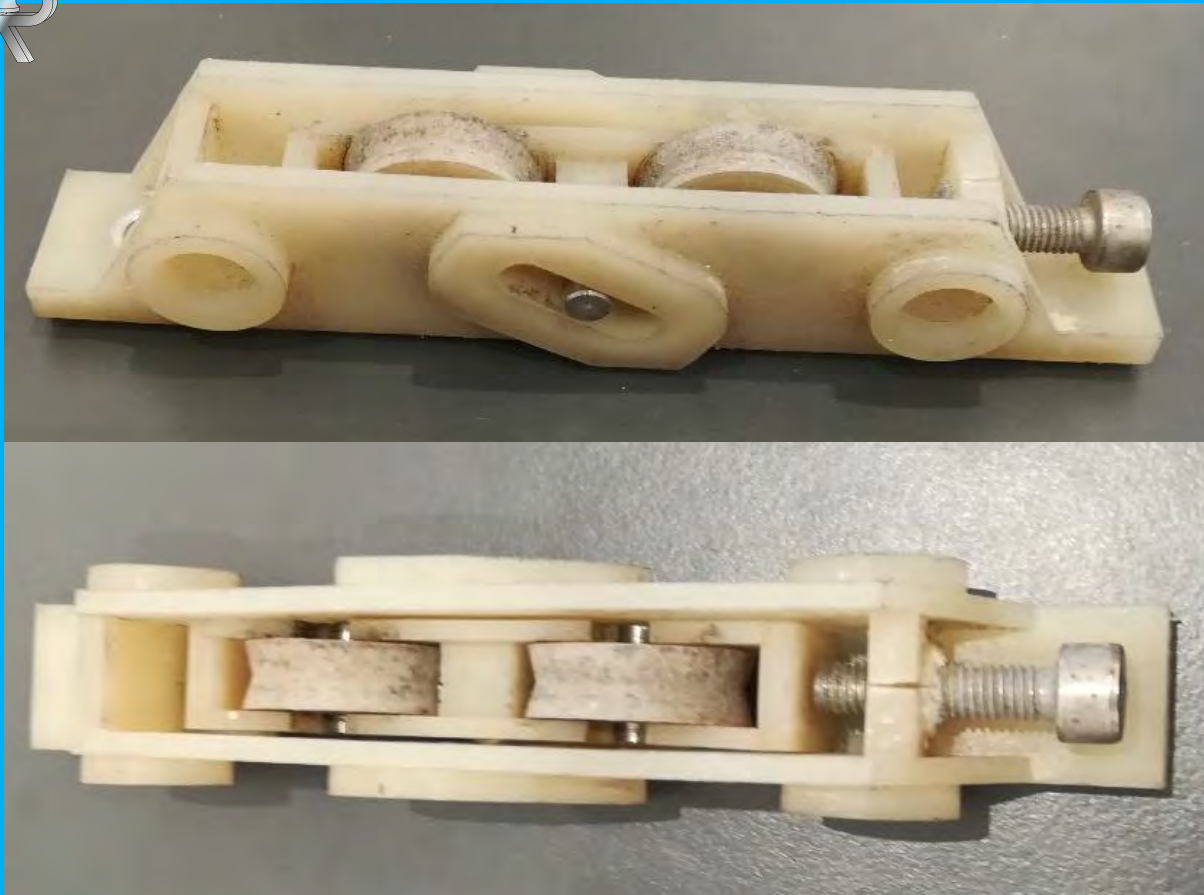
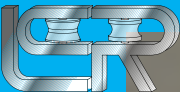

AC022

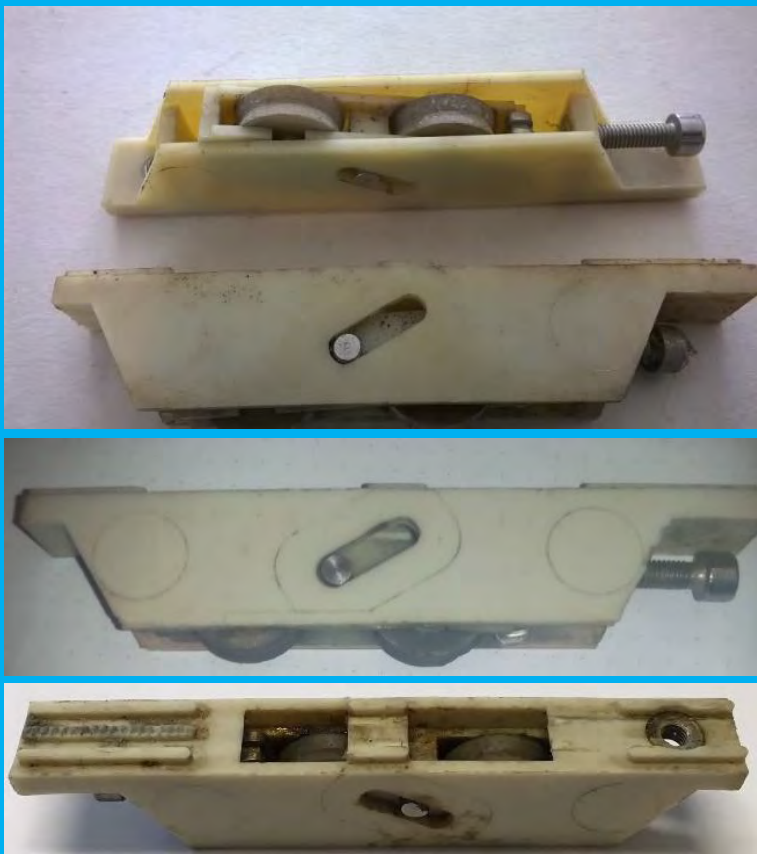
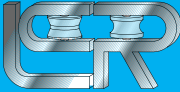

AC023

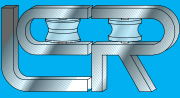

AC024

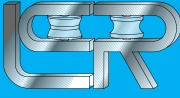

AC025

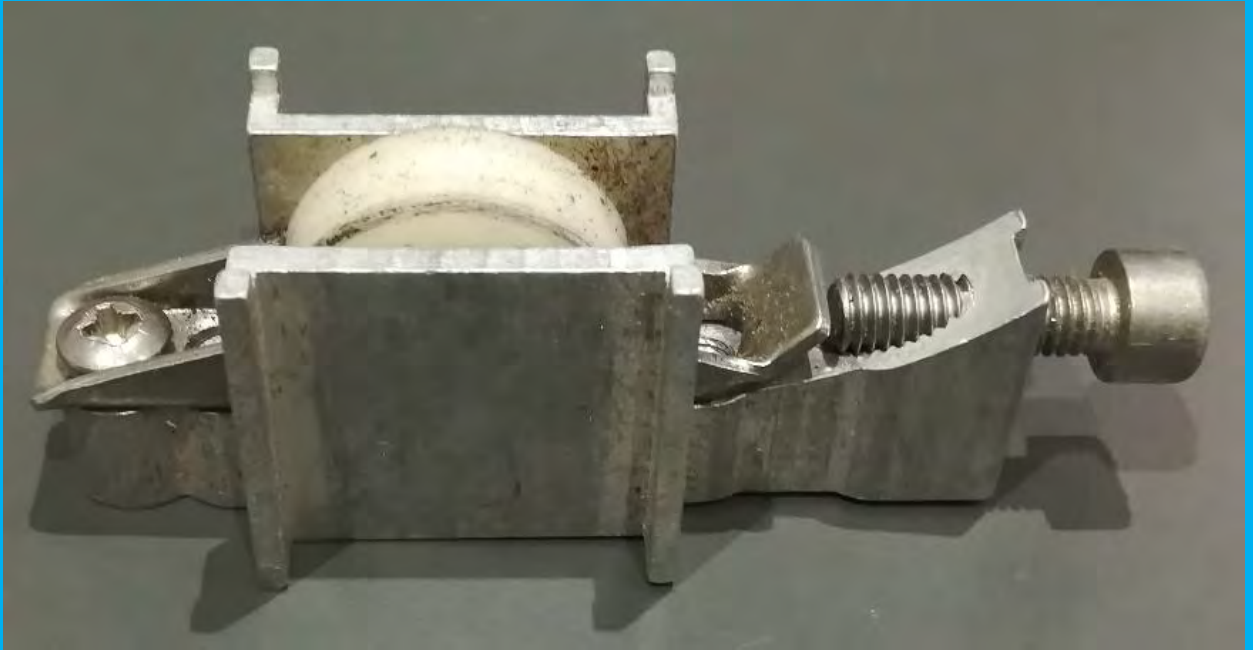
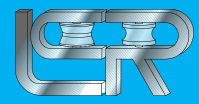

AC026

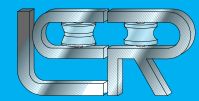

AC027

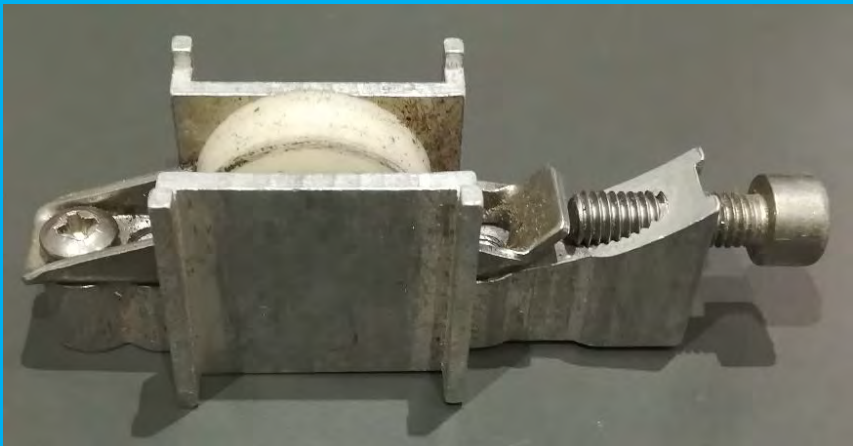

≠ DIMENSIONS



AC028

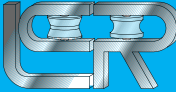

AC029

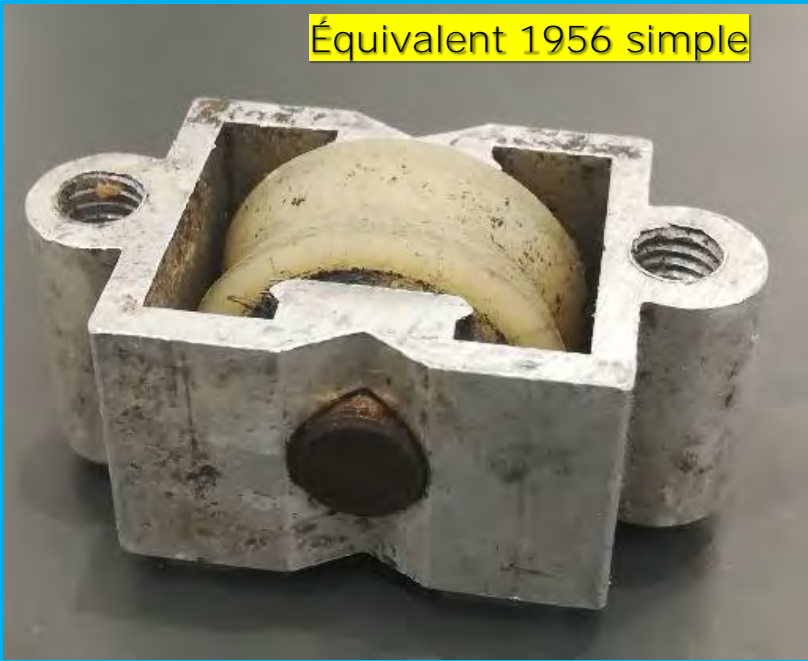
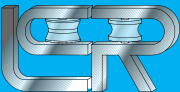

AC030

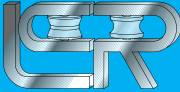

ACO31

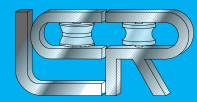

Code cage : 3443B

Code chariot : 3447A

ACO32



AC033

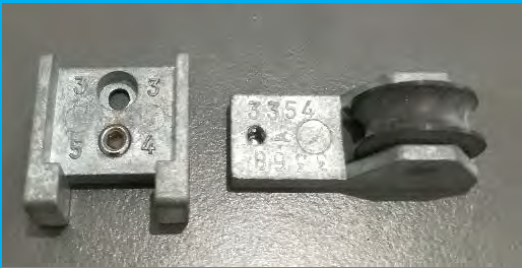
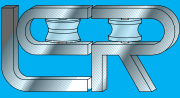

AC034

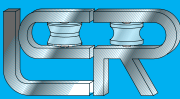

(WICONA)



AC035

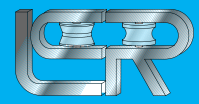

AC036

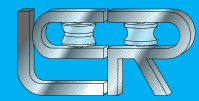

✓Code SODIAL : QC 201

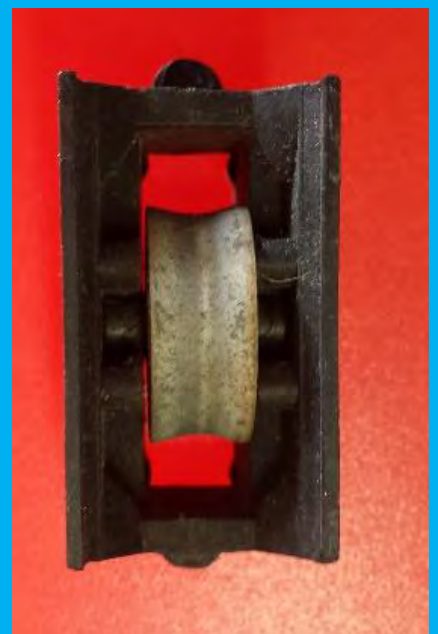

AC037

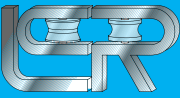

AC038

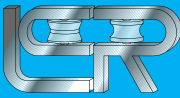

FAPIM cde : chariot QAAP/cage GFAA



AC039

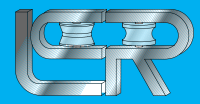

AC040

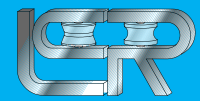

ACO41

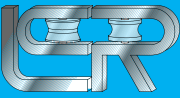

ACO42

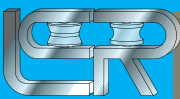

ACO43

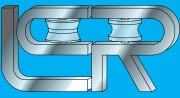

ACO44

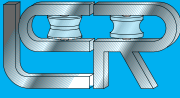

ACO45

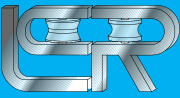

ACO46

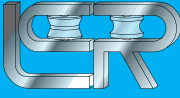

ACO47



ACO48

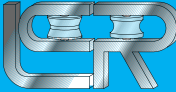

AC049

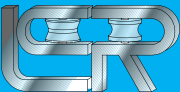

AC050

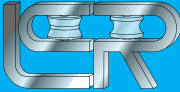

AC051

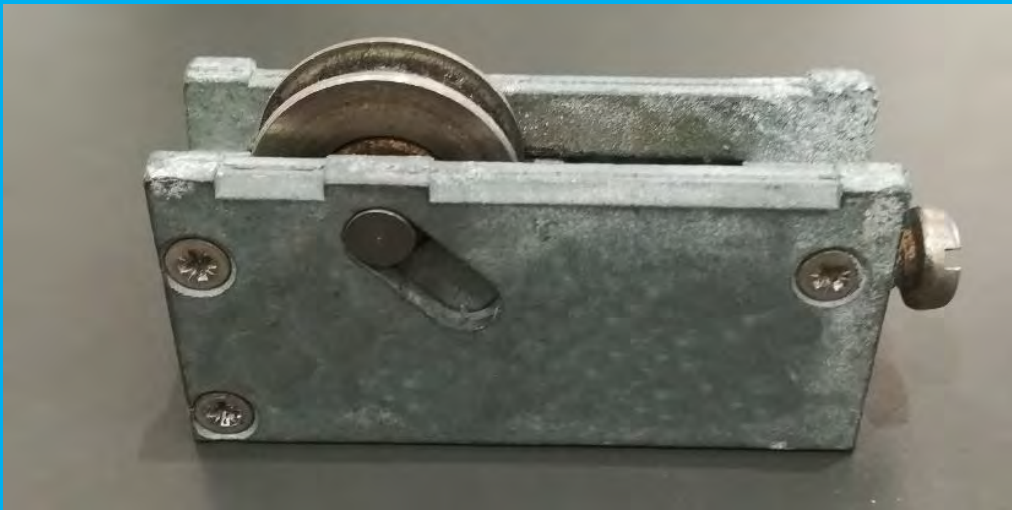
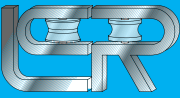

AC052

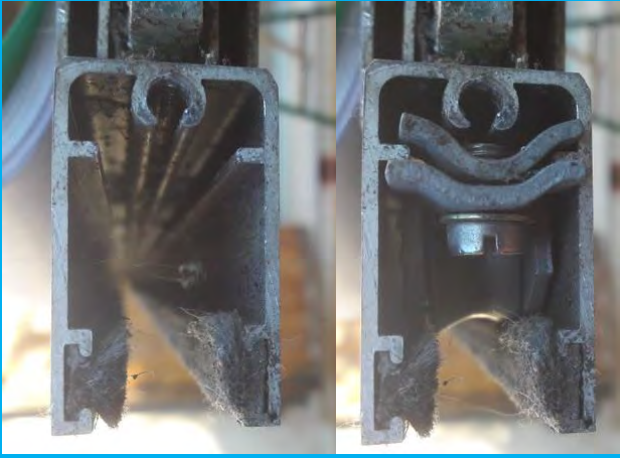
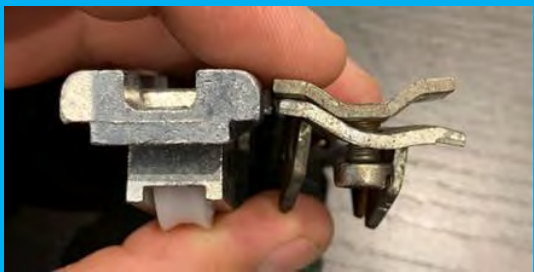
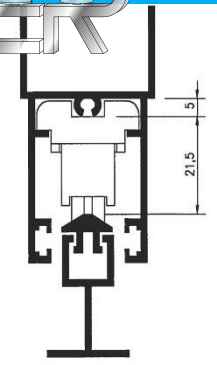
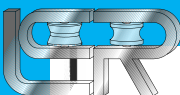

Largeur : 20mm=DGR2062

Largeur : 24mm=DGNR3317

AC053

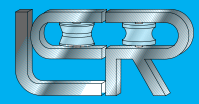

✎ Existe en 20 mm de large



AC054

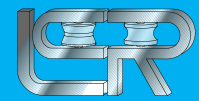

AC055

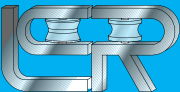

AC056

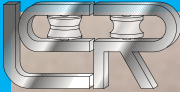

AC057

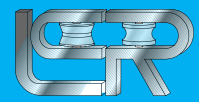

SCHÜCO 213563

L : 25,2 H : 21,4

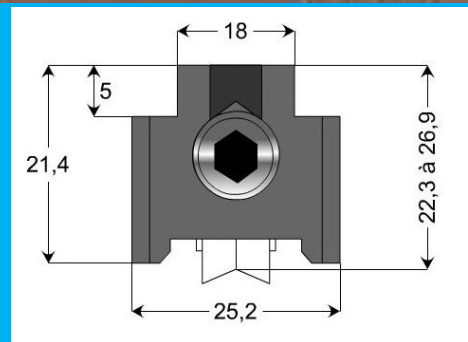

AC058

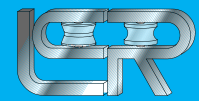

AC59

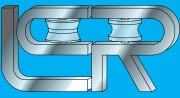

AC60

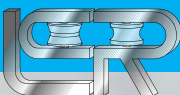

AC061

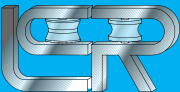

AC062

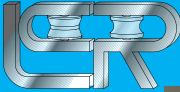

AC063

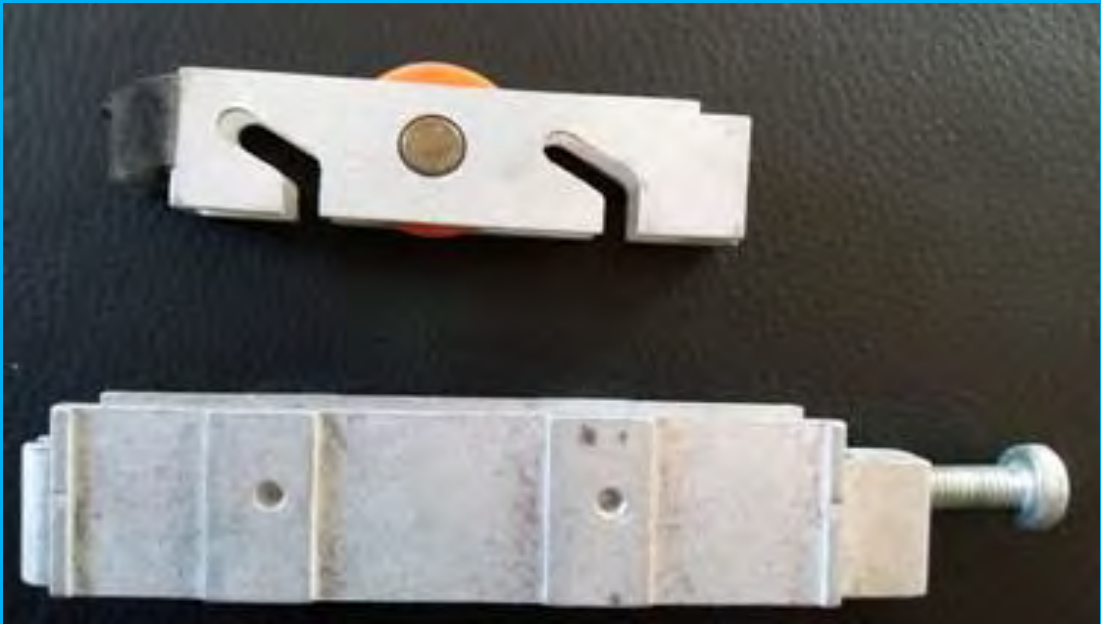
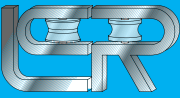

AC064

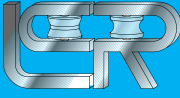

Code sur chariot : 588R
687



AC065

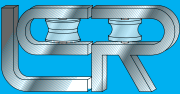

AC066

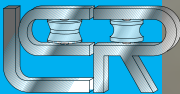

AC067

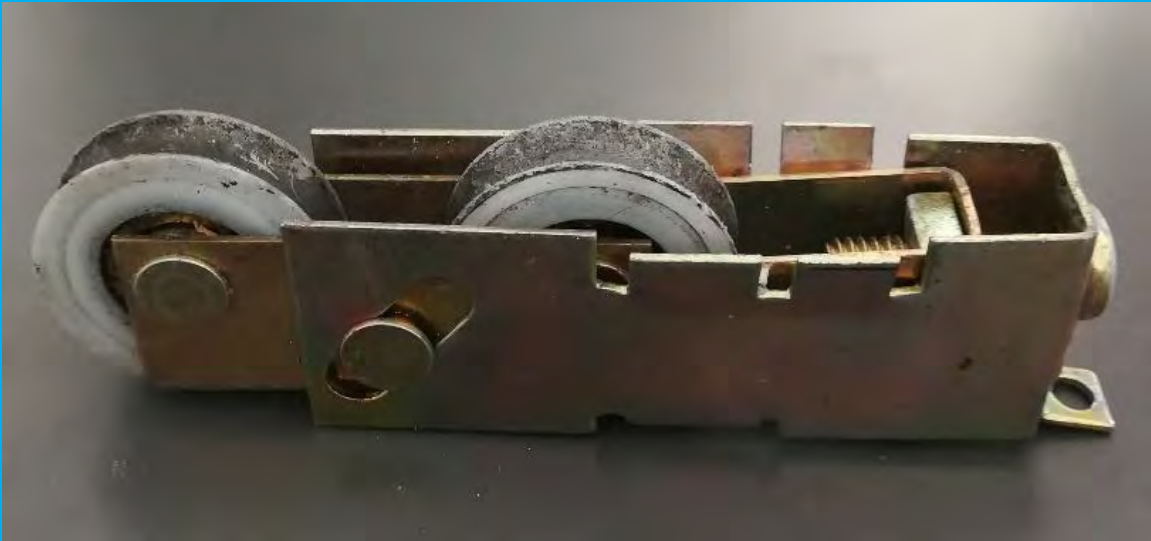
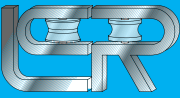

AC068

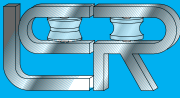

AC069

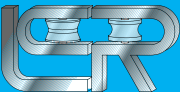

AC070

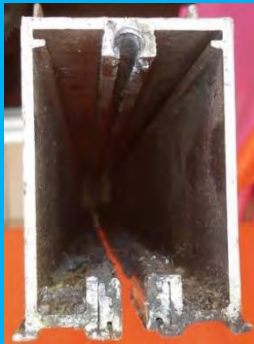

AC071

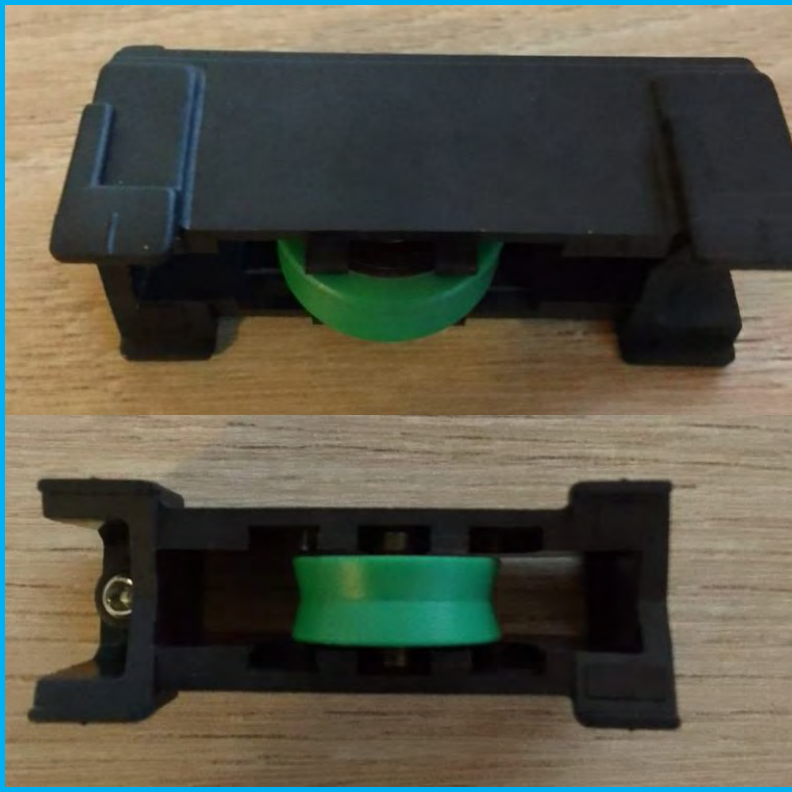
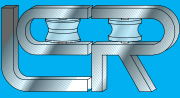

AC072

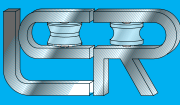

AC073

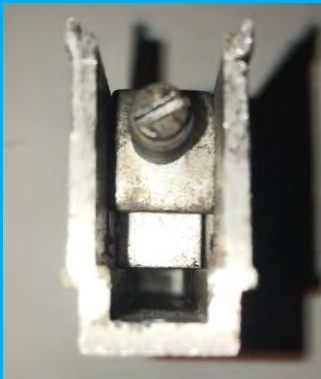
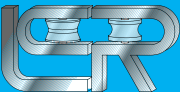

AC074

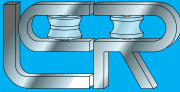

AC075

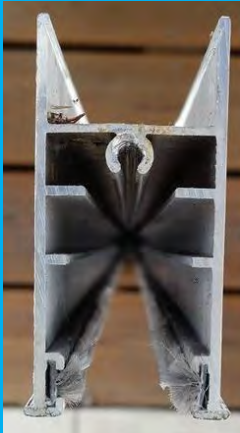
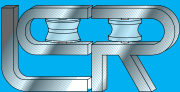

AC076

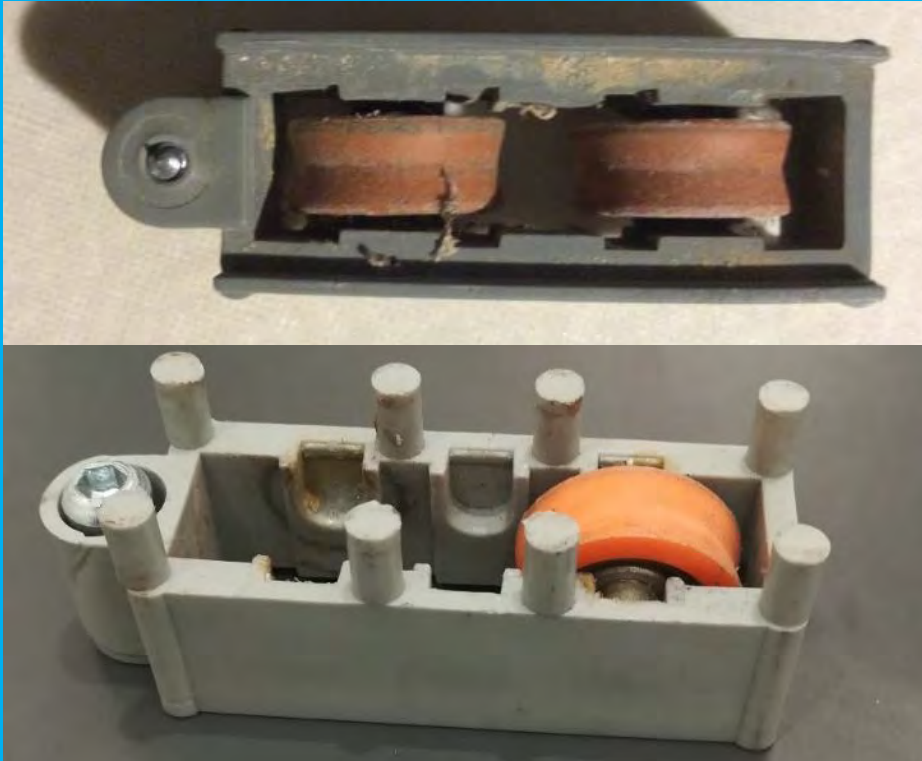
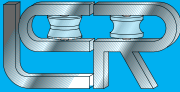

AC077

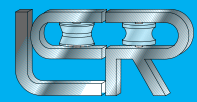

✓A51845101



AC078

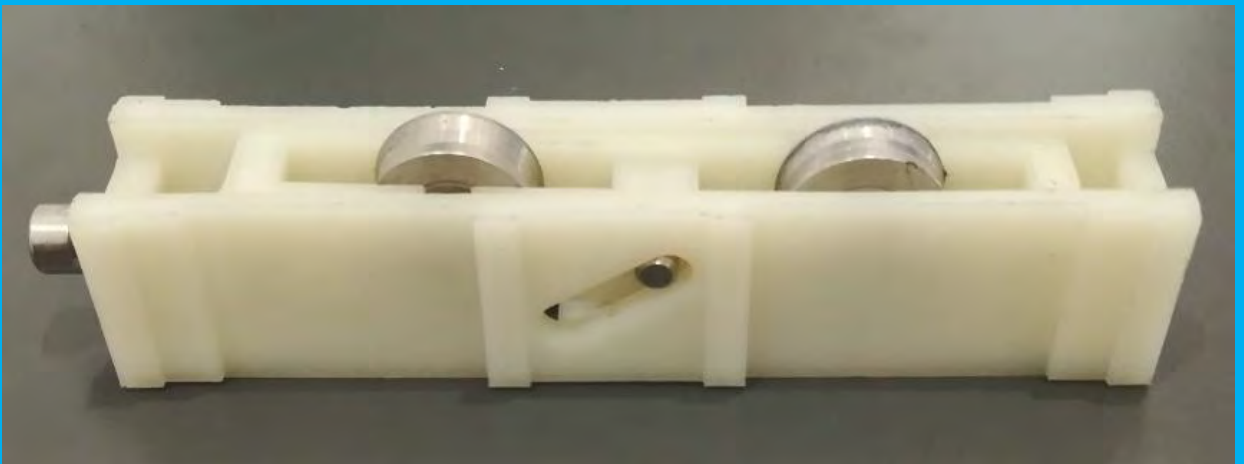

AC079

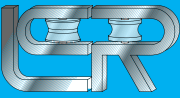

✓Code Chariot : 2 E11806



AC080

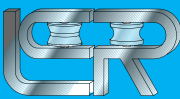

Code Chariot :

CT-475



AC081

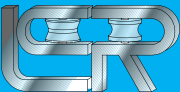

AC082

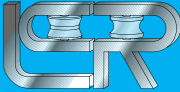

AC083

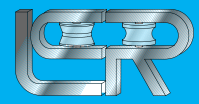

AC084

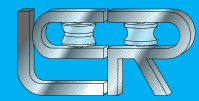

Chariot: 3844A

Cage: 3734B

AC085

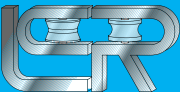

AC086

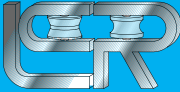

AC087

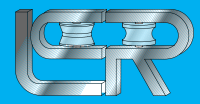

AC088

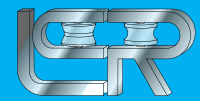

AC089

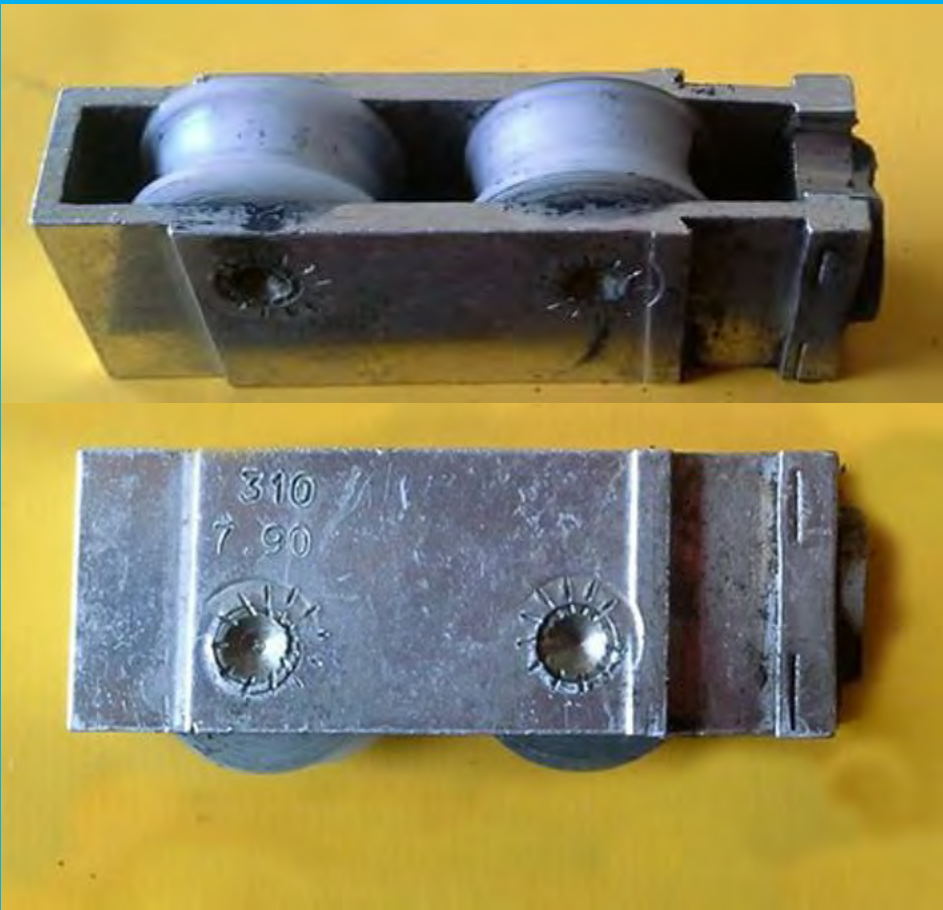
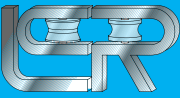

AC090

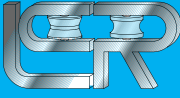

AC091

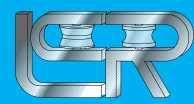

✓DGR2152.1 ou 2150.1

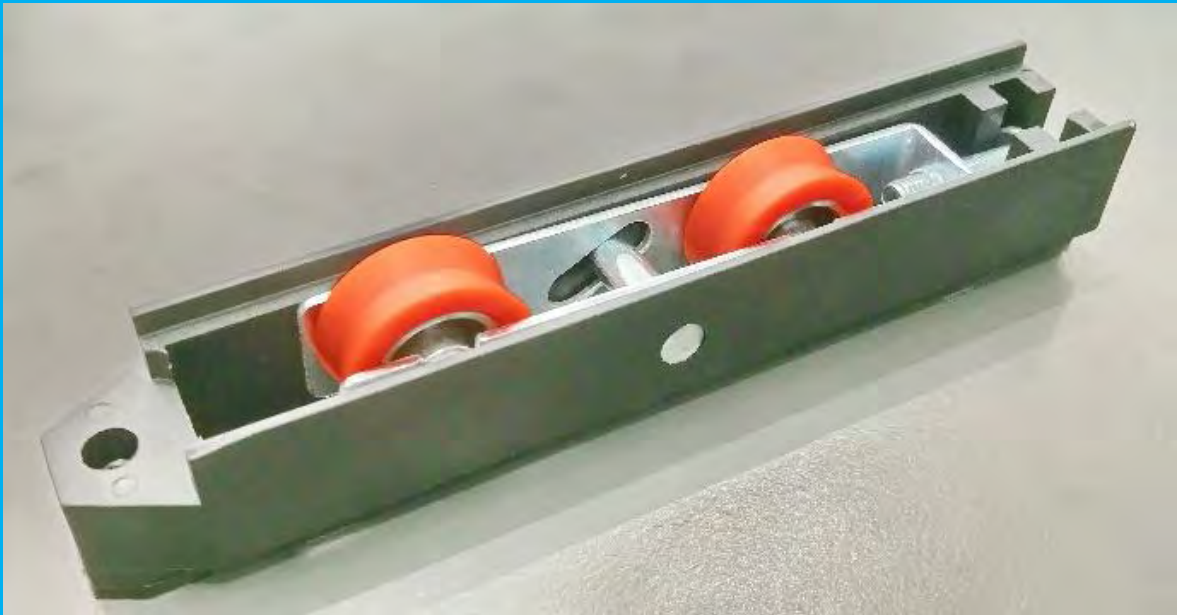

AC092

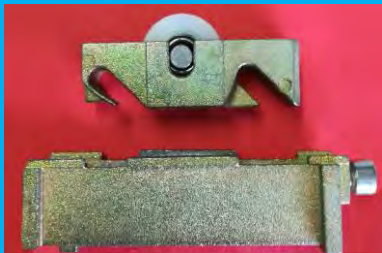
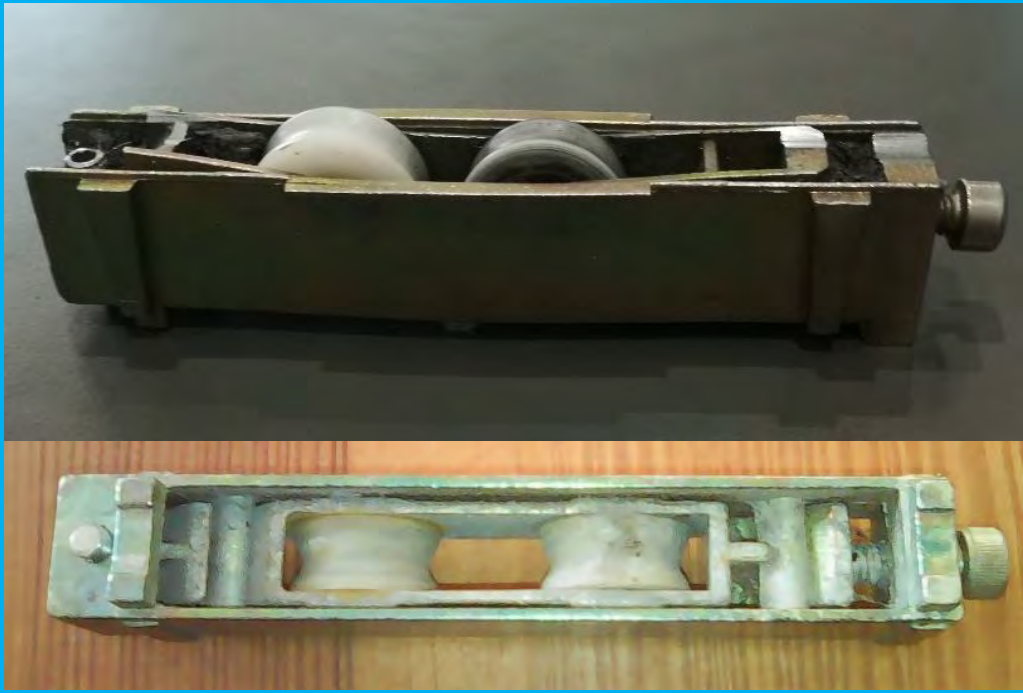

AC093

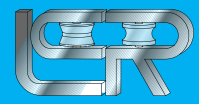

AC094

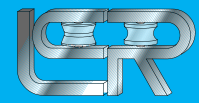

AC095

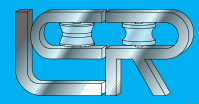

AC096

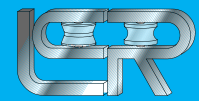

AC097

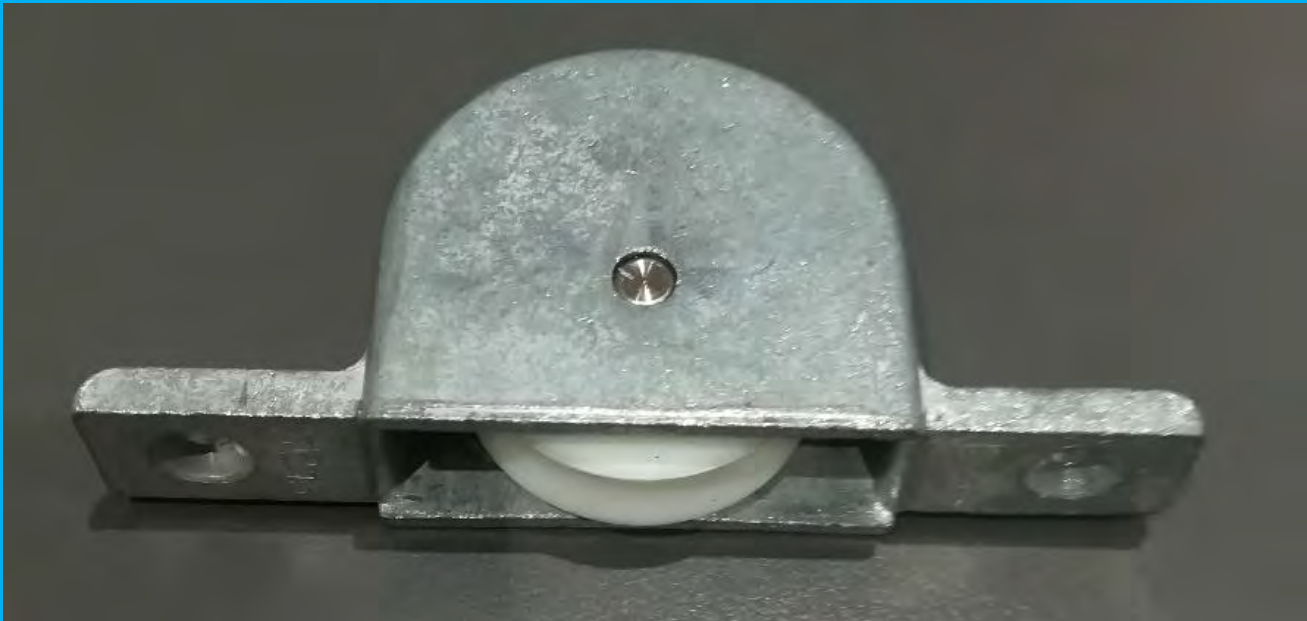

AC098

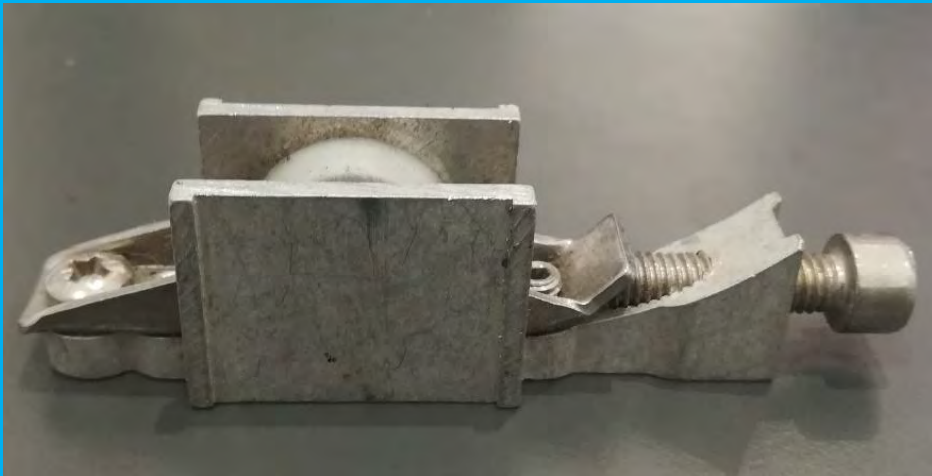
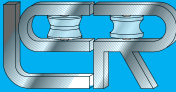

AC099

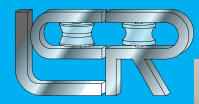

AC100

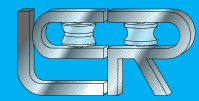

AC101

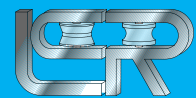

AC102

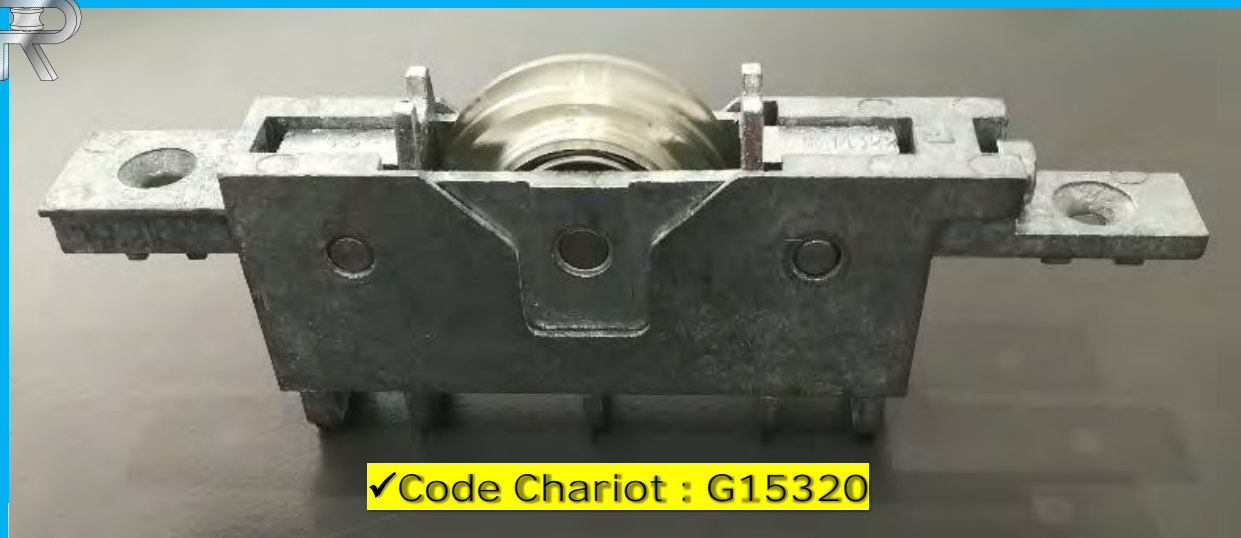
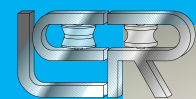

✓Code Chariot : G15320



✓Code Cage : E14322

AC103

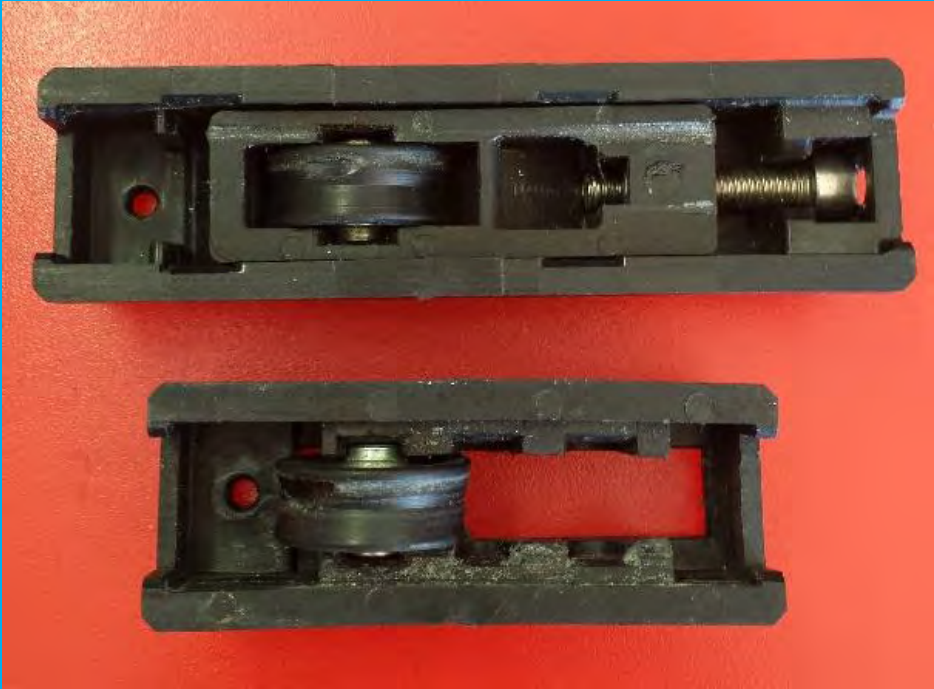
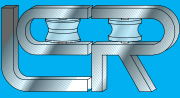

AC104

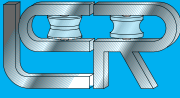

AC105

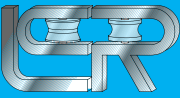

AC106

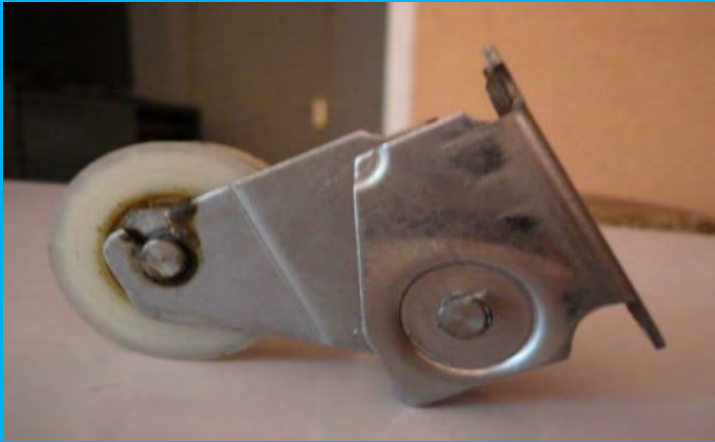
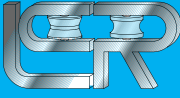

AC107

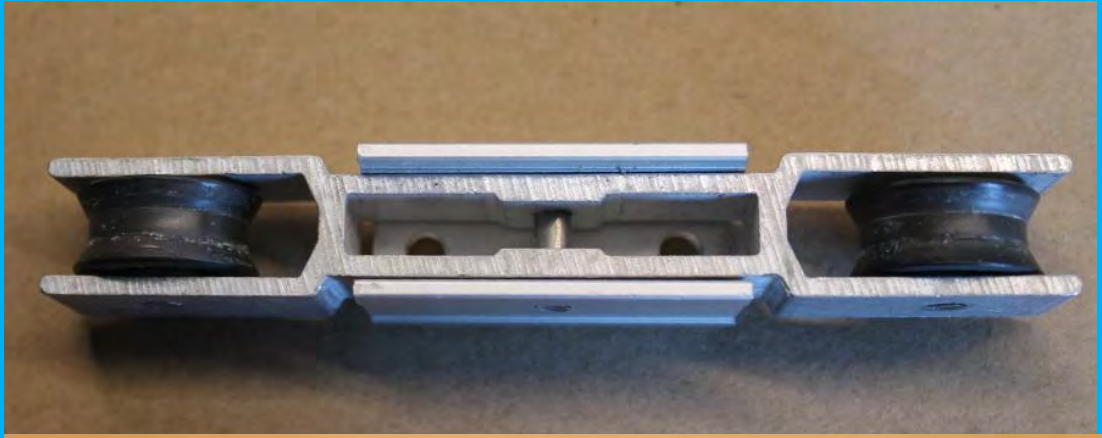
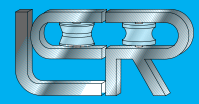

AC108

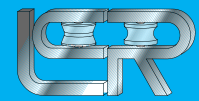

AC109

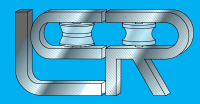

AC110

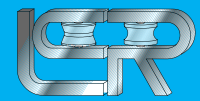

AC111



AC112



AC113

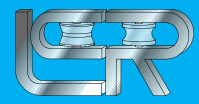

FERCO GU ORPHÉA G11389



Coulissant bois

AC114

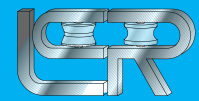

AC115

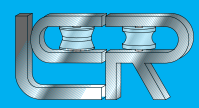

AC116



AC117

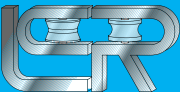

AC118

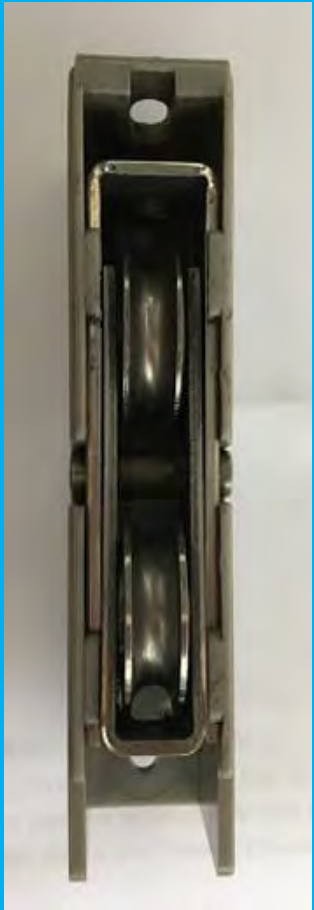

AC119

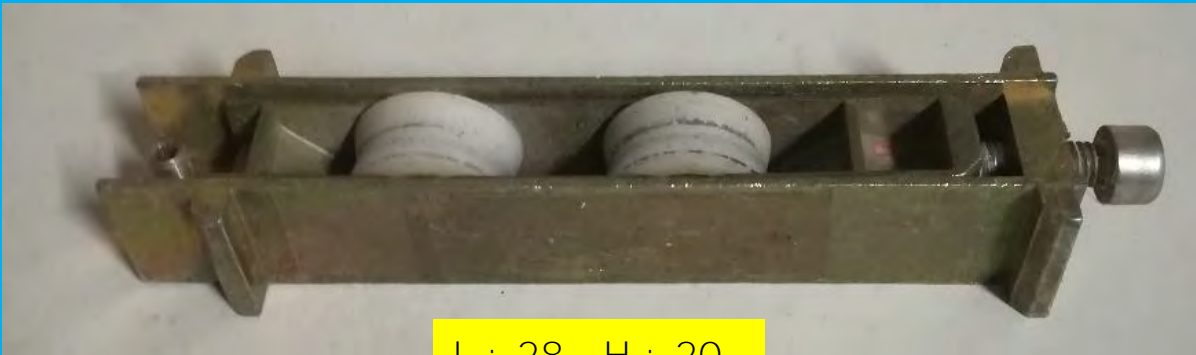
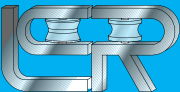

L : 28 H : 20

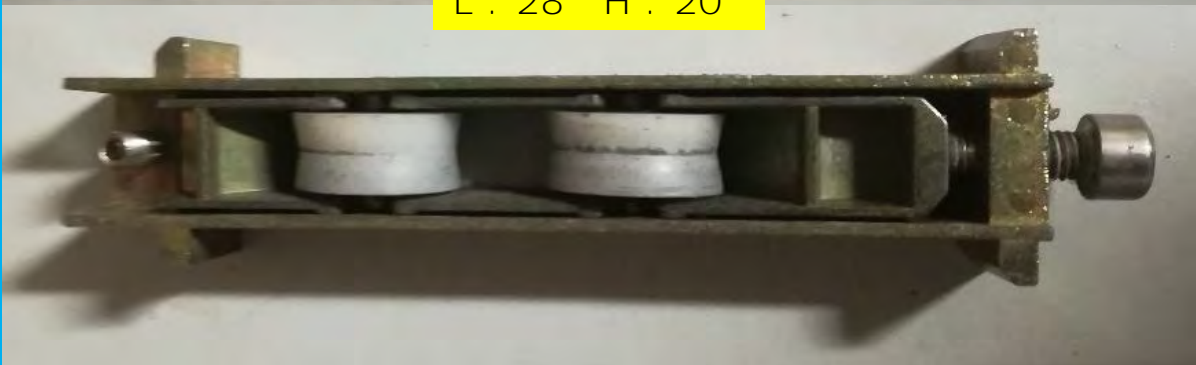

AC120

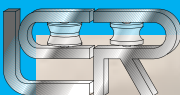

L : 30 H : 16



16

140

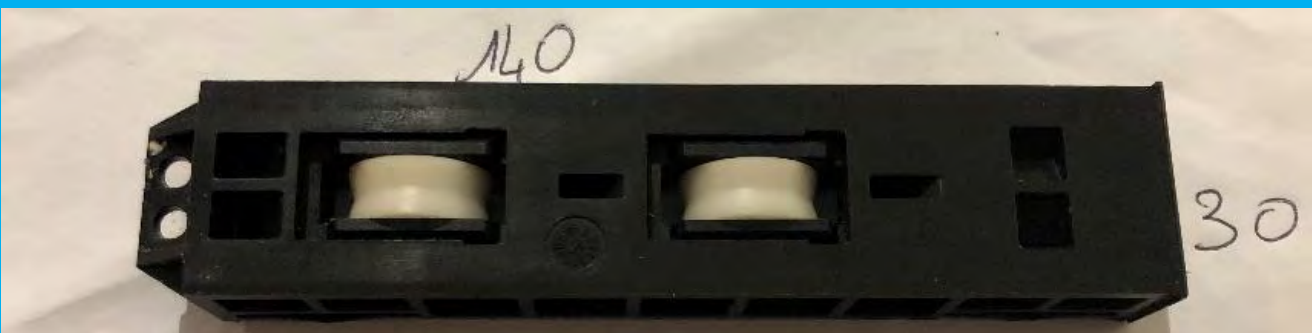

140

30

AC121

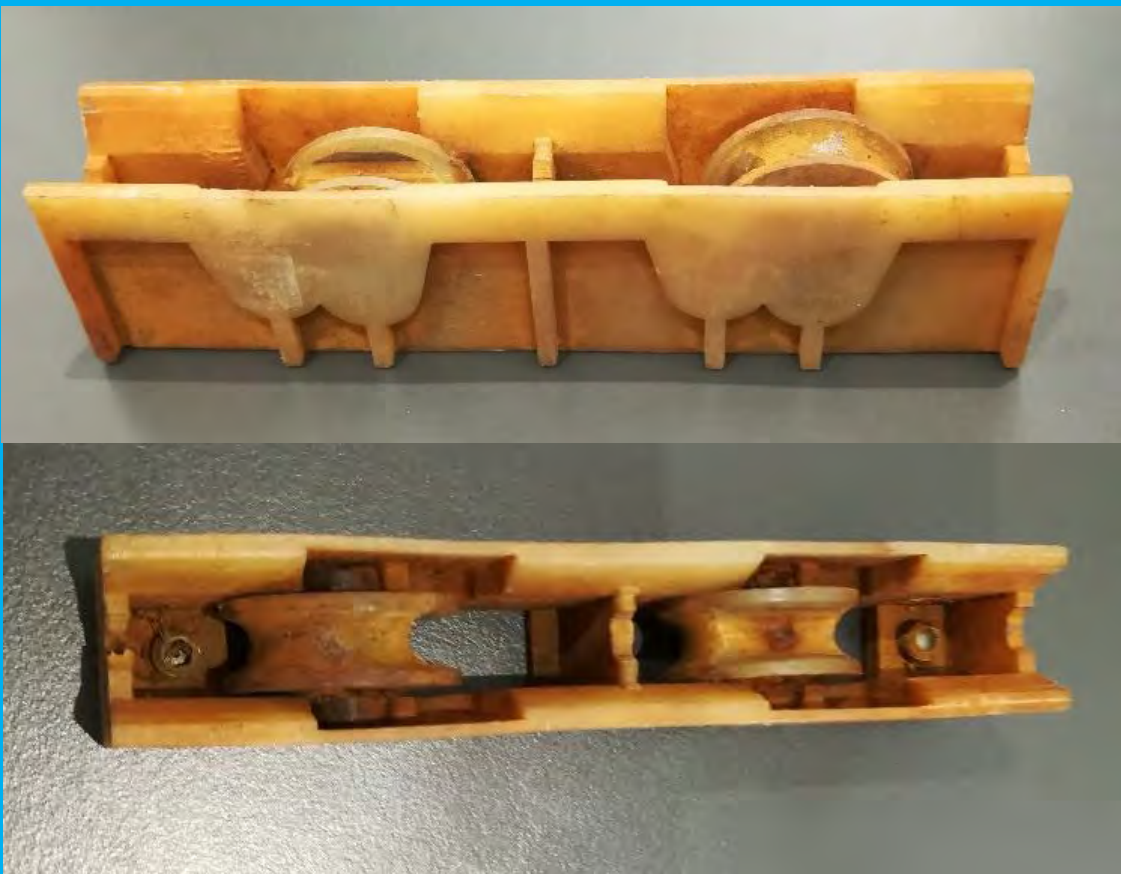
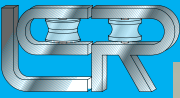

AC122

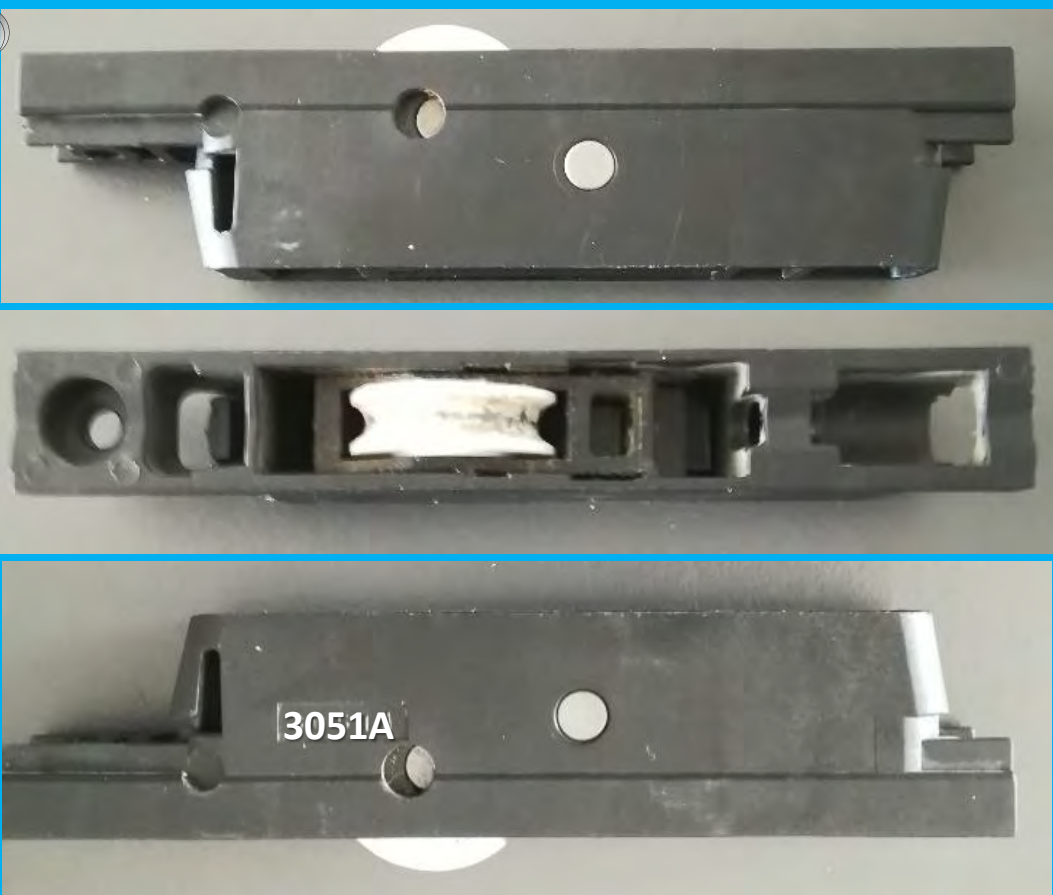
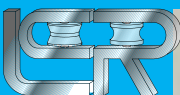

AC123

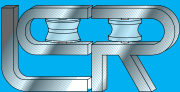

L : 18 H : 21



AC124

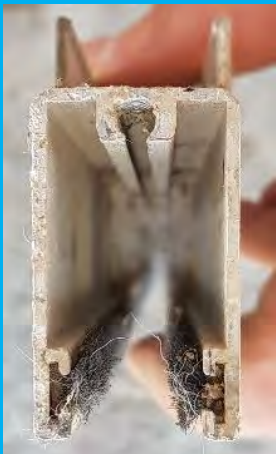

AC125

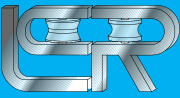

AC126

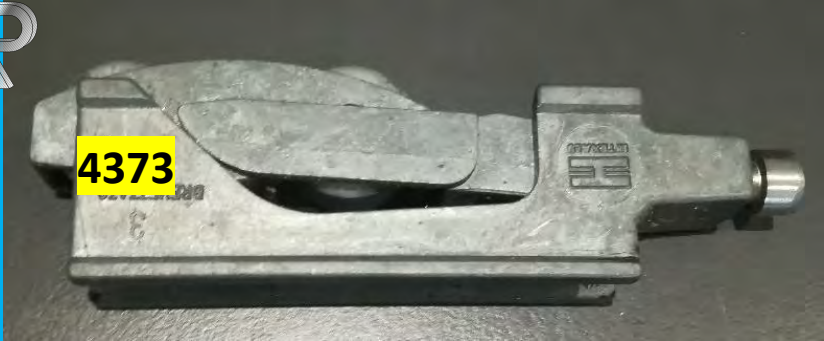
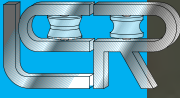

AC127

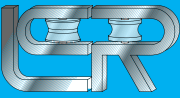

AC128

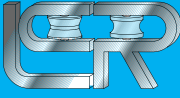

AC129

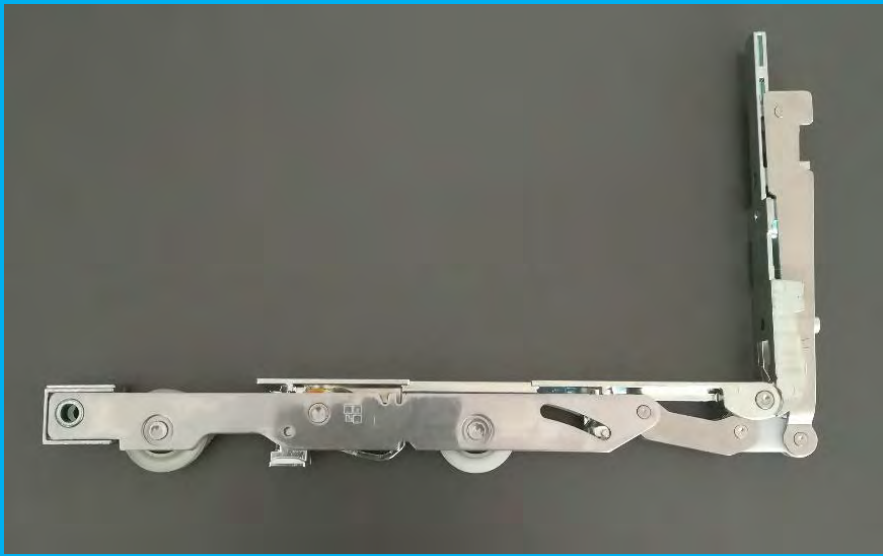

AC130

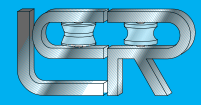

AC131

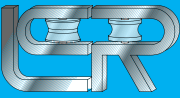

AC132

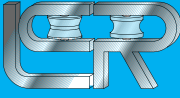

AC133

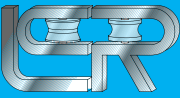

AC134

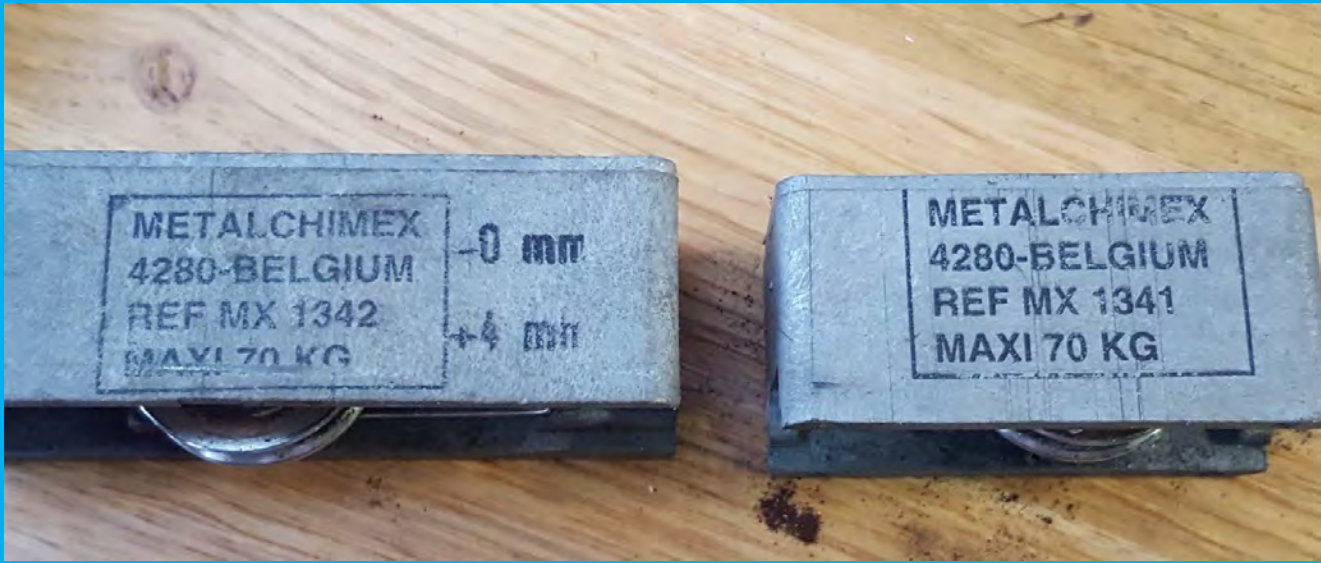
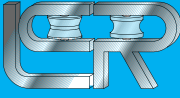

AC135

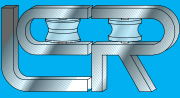

✓Code Chariot : MX96854



AC136

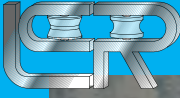

✓Code Chariot : MX96837



AC137

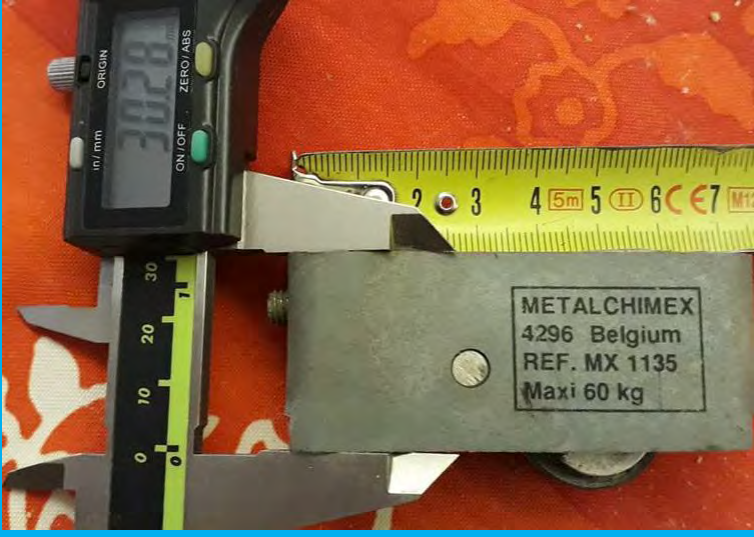
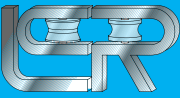

AC138

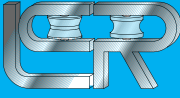

L : 22,3 H : 27,5



AC139

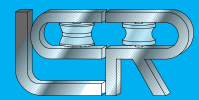

FAPIM code : chariot QAAP/cage GFAA



AC140

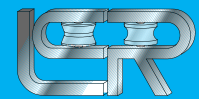

AC141



Disponible en original : CG011



AC142

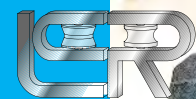

AC143

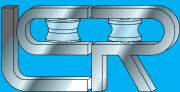

AC144



AC145

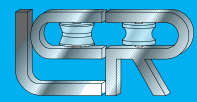

Disponible en K-LINE : 20389



KAWNEER 8001636 (SGR) R3



AC146



L : 23 H : 28



AC147

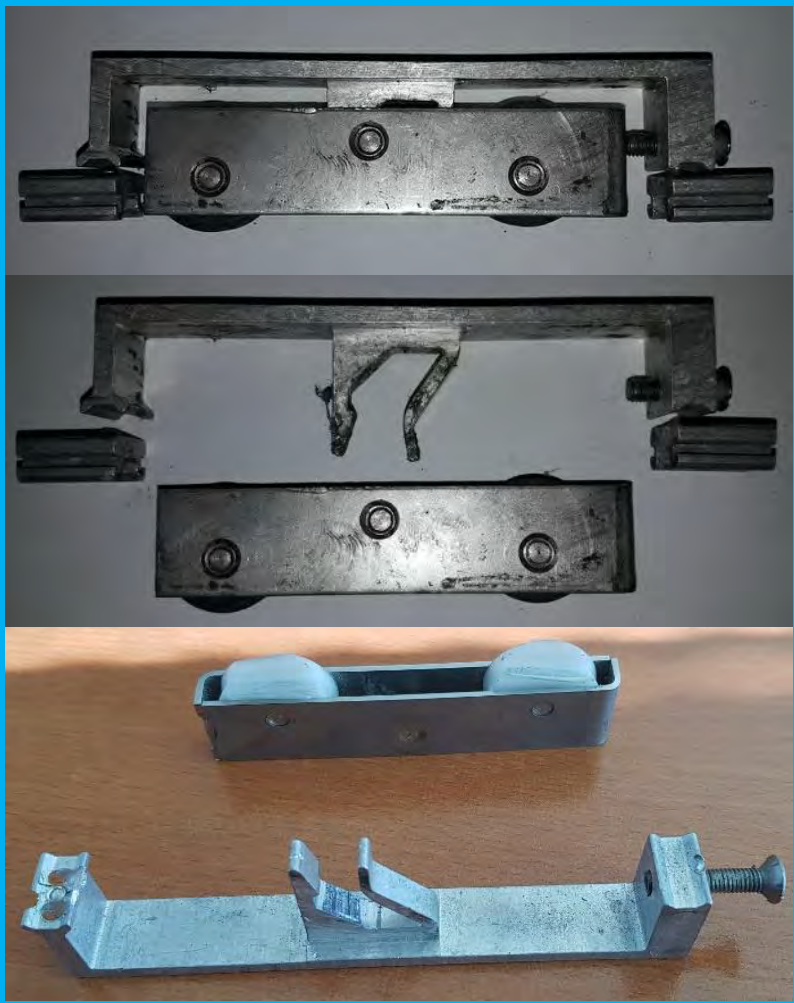
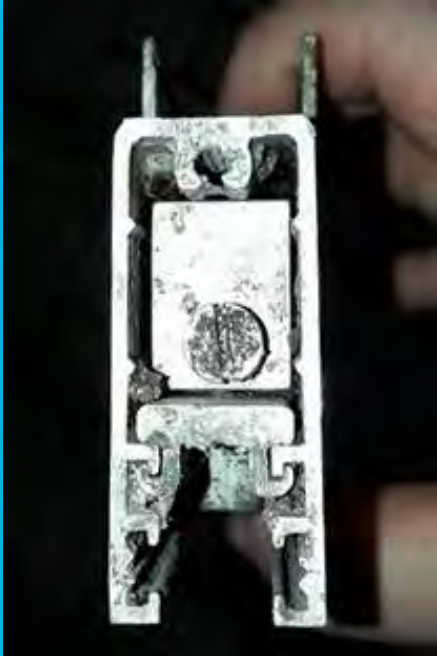
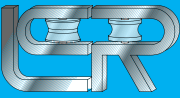

AC148

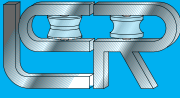

Disponible en TECHNAL : CG011



AC149

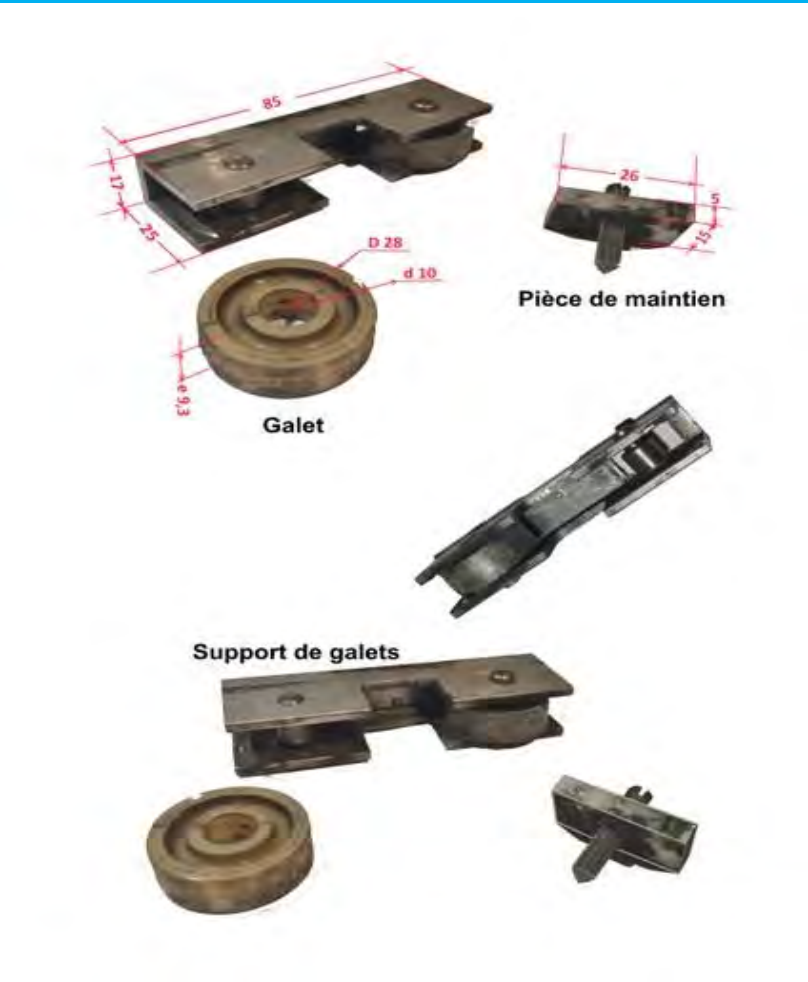
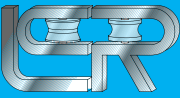

AC150

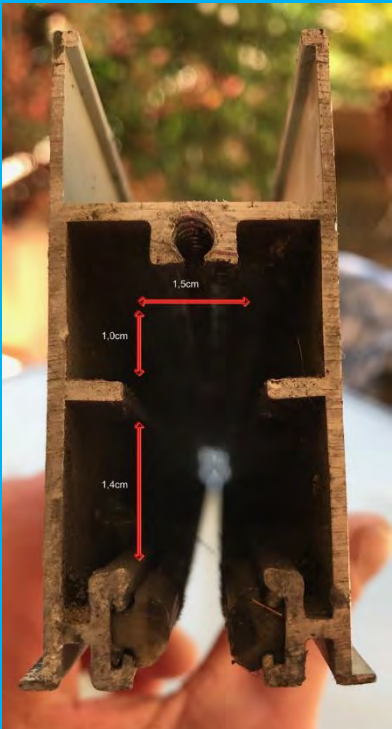
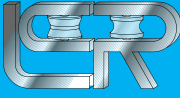

AC151

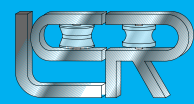

L: 16 H: 12

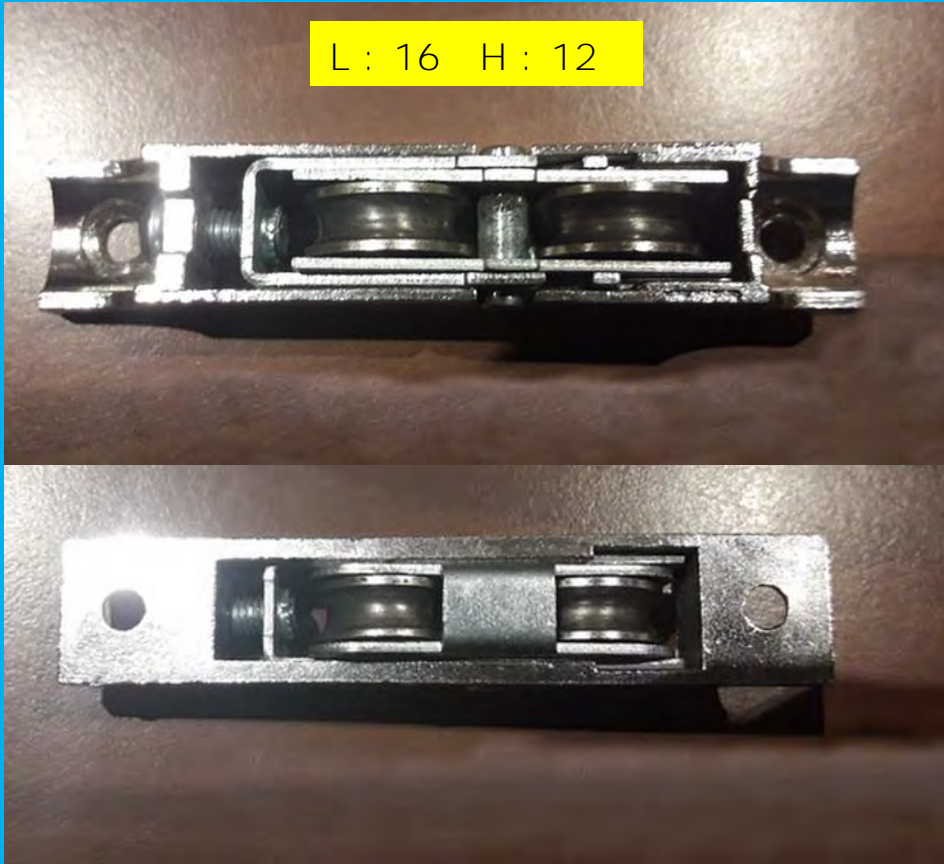

AC152



AC153

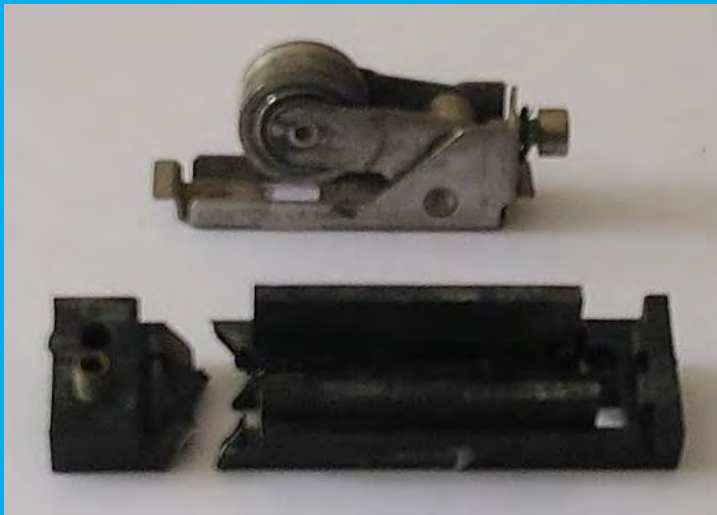
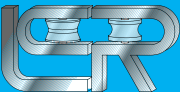

AC154

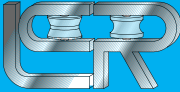

AC155

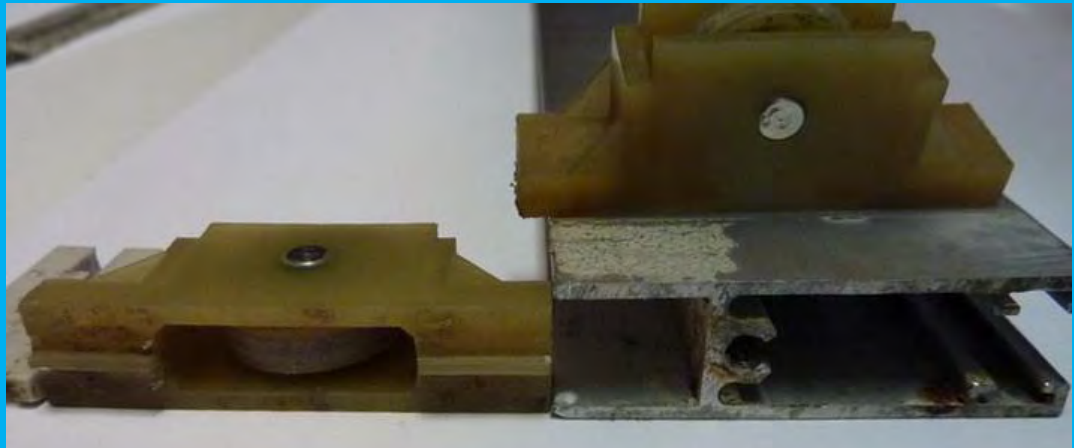
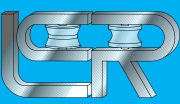

AC156

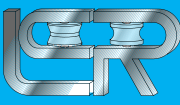

AC157

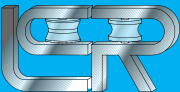

AC158



AC159

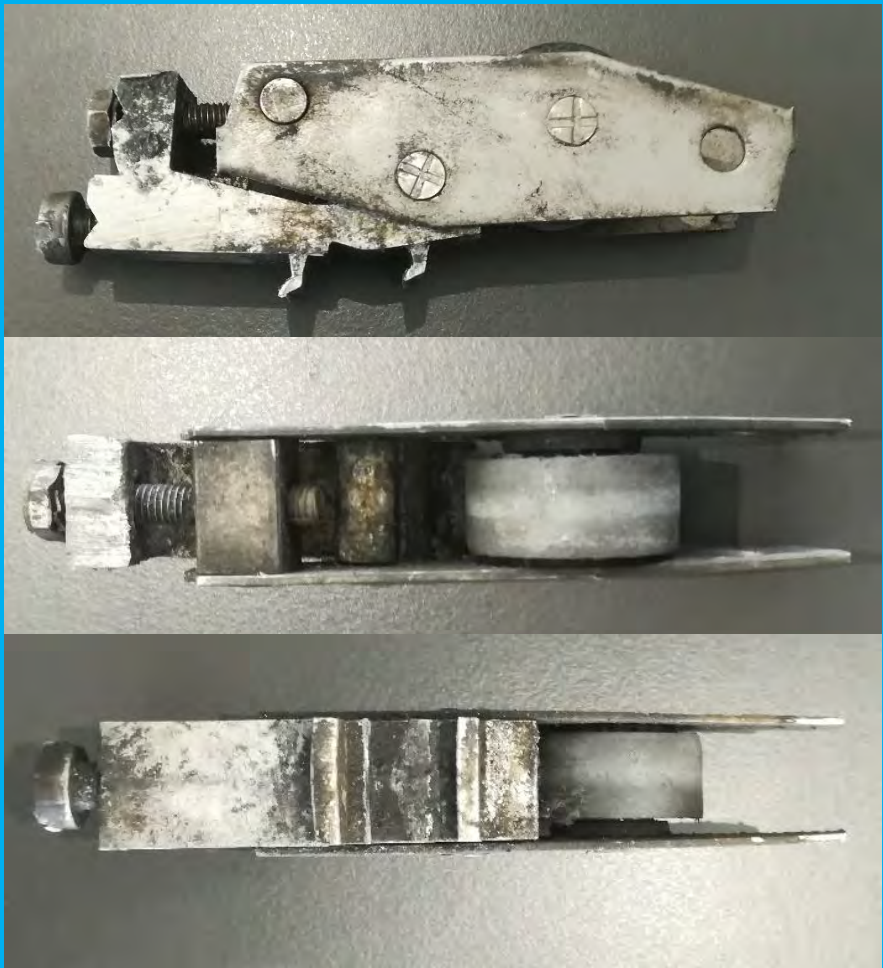
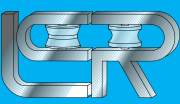

AC160

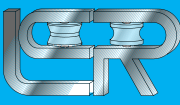

AC161

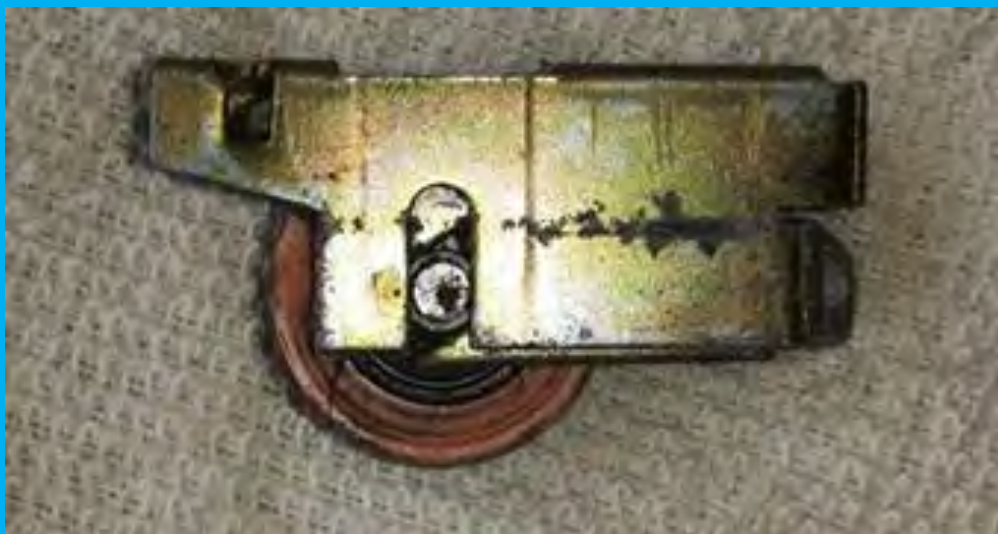
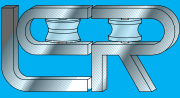

AC162

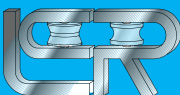

AC163

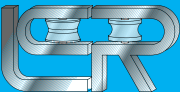

AC164

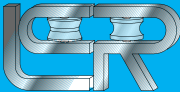

AC165

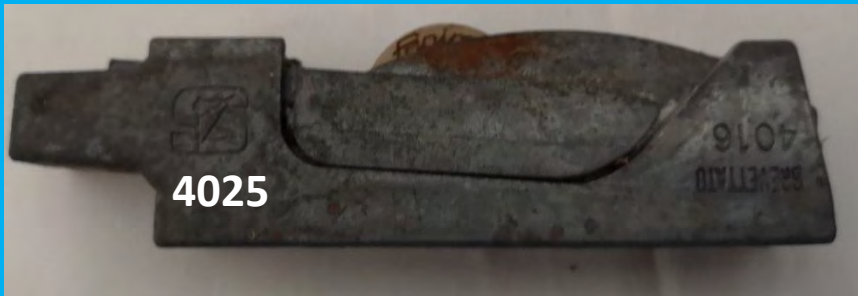
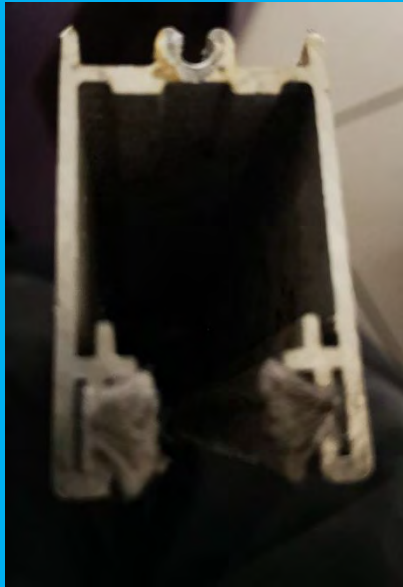
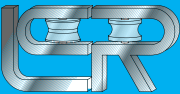

4025

4016
BACETTADU

AC166

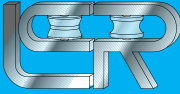

3848A

AC167

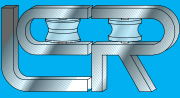

AC168

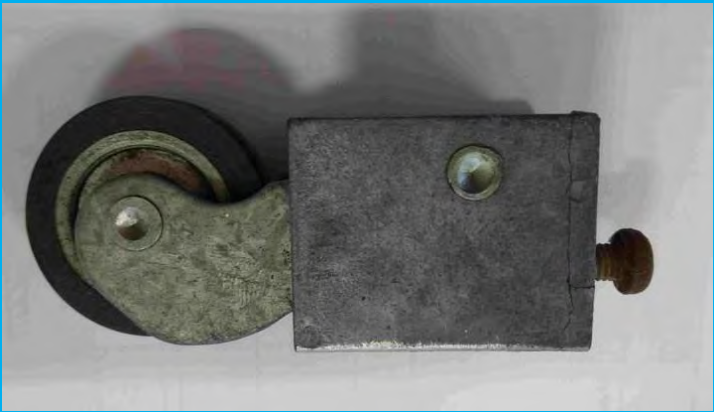
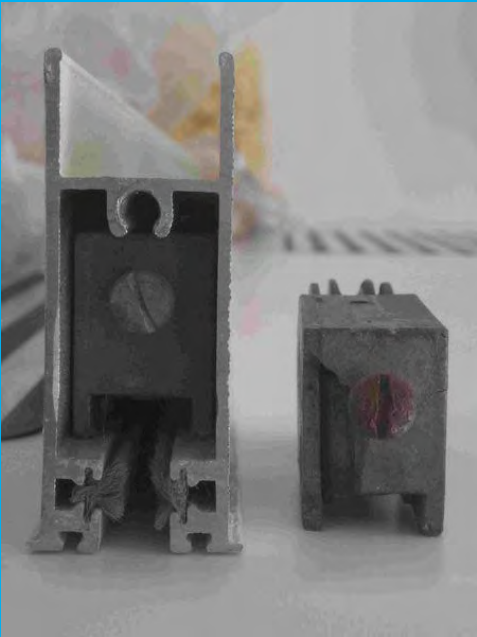
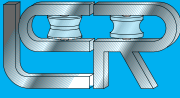

AC169

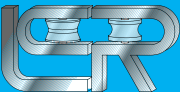

L : 19,5 H : 38,5



AC170

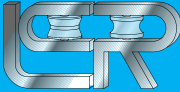

AC171

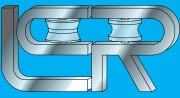

AC172

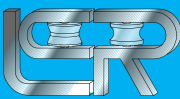

Disponible en original : SGR8001636

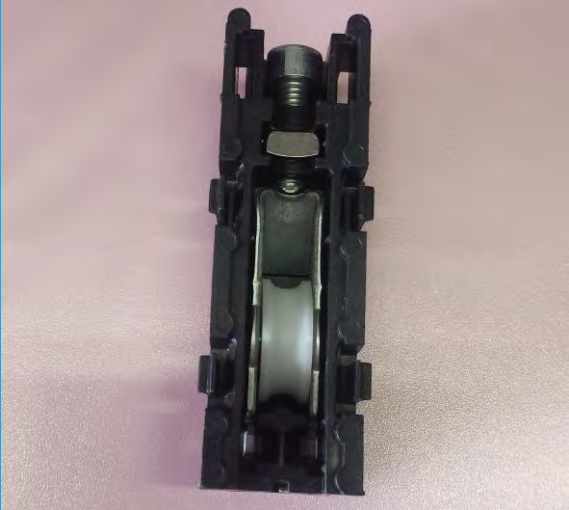

AC173

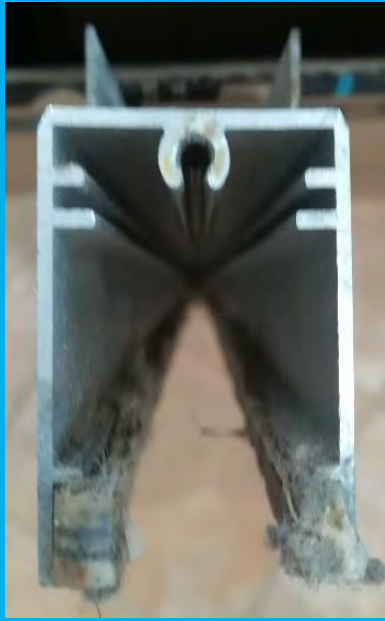
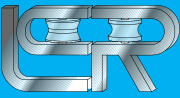

AC174

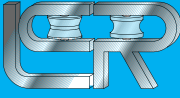

AC175

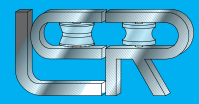

✓Code Chariot : G15202



AC176

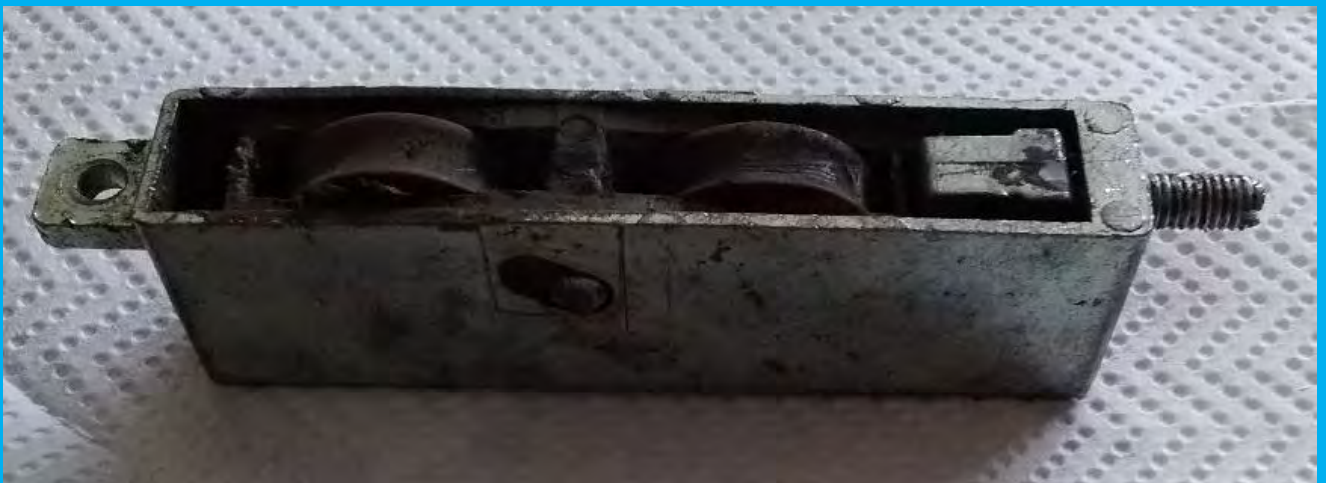
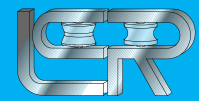

AC177

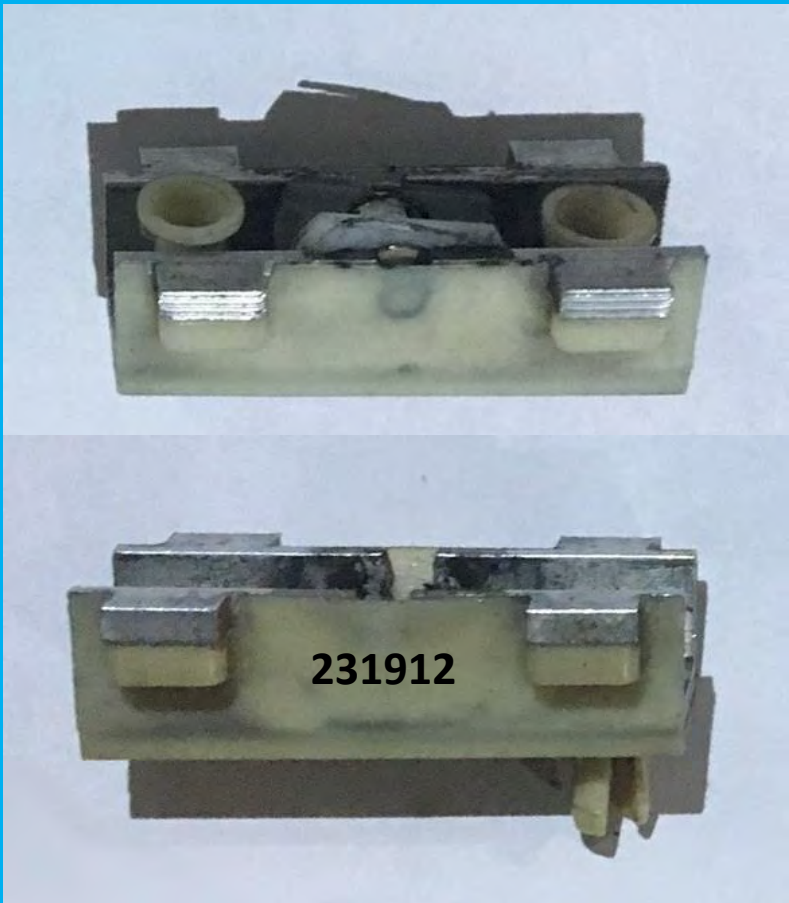

AC178

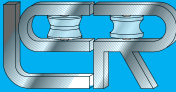

AC179

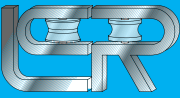

AC180

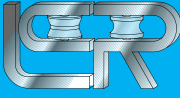

AC181

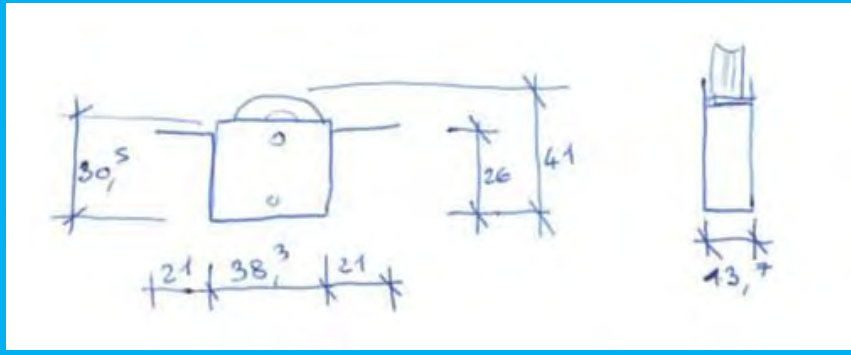
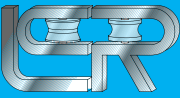

AC182

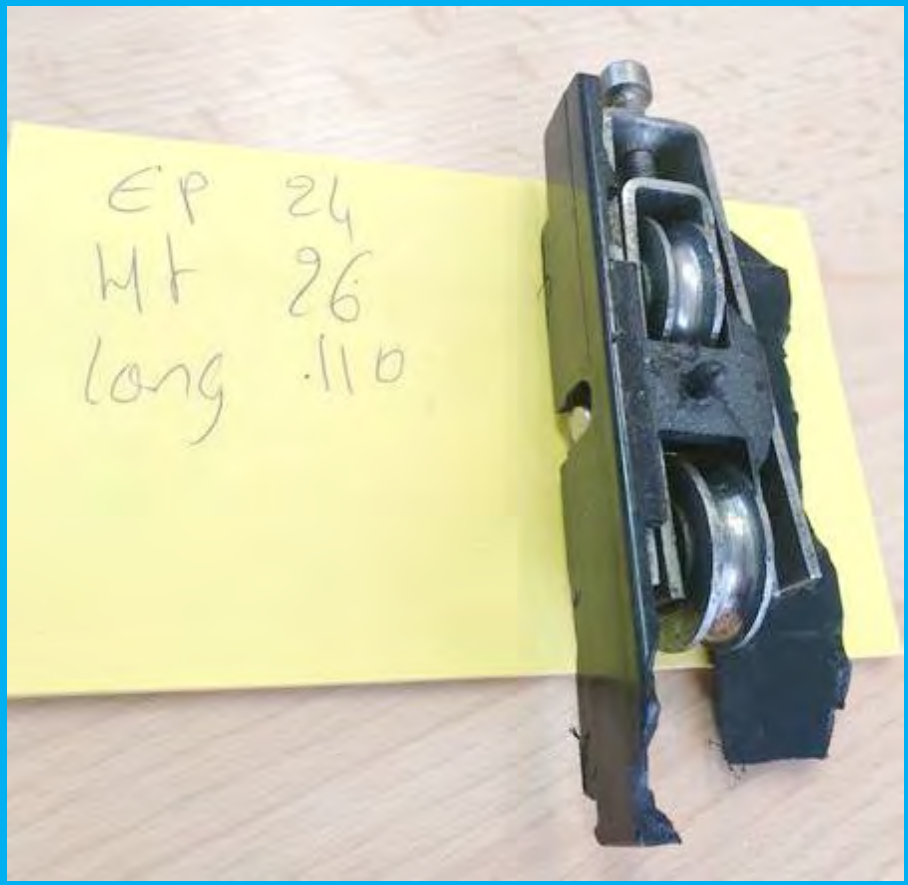
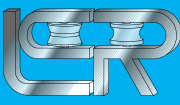

EP 24
Mt 26
long .110

AC183

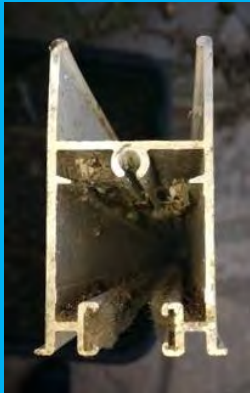
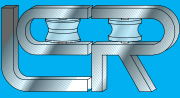

AC184

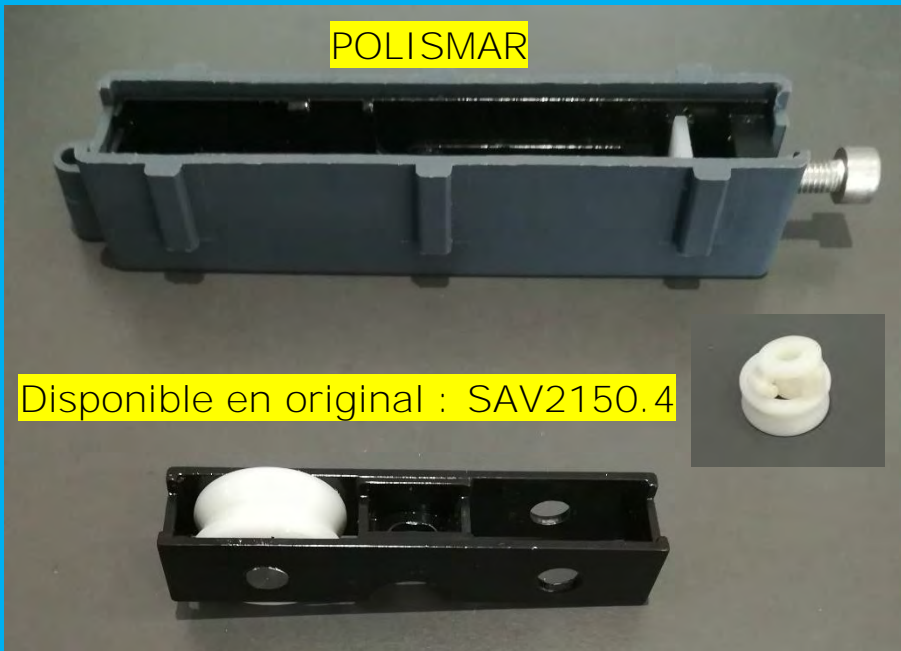
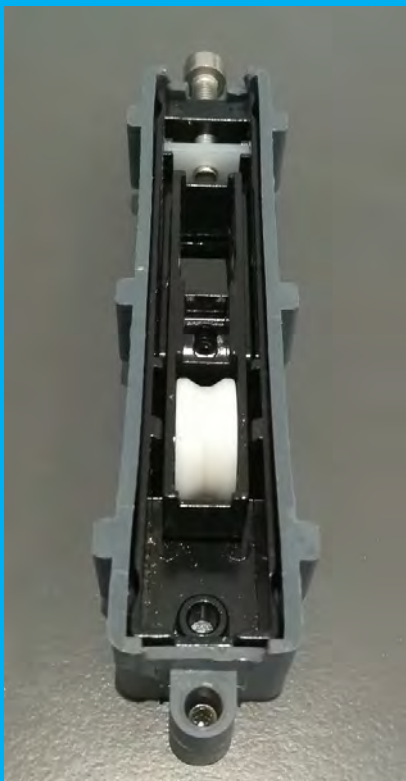
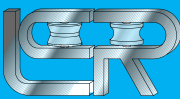

AC185

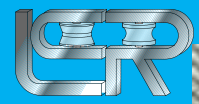

L : 22 H : 20



AC186

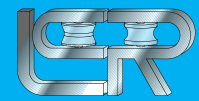

AC187

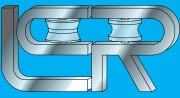

AC188

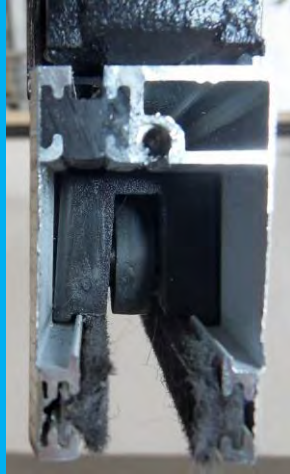
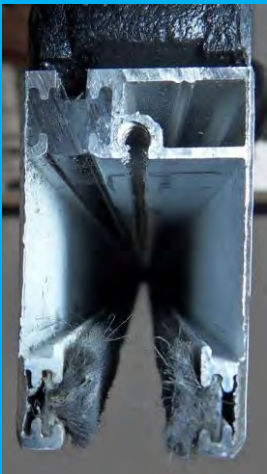
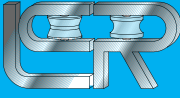

AC189

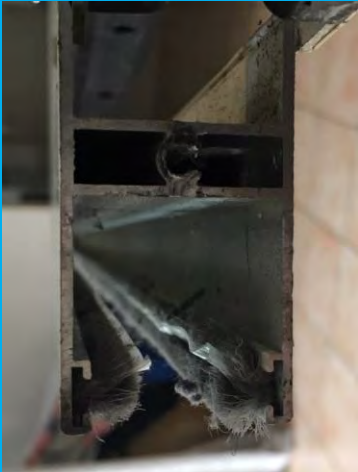
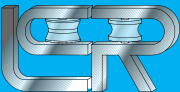

AC190

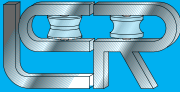

AC191

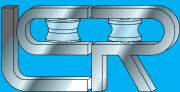

AC192

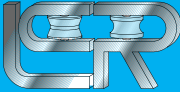

AC193

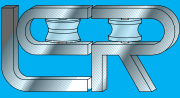

AC194

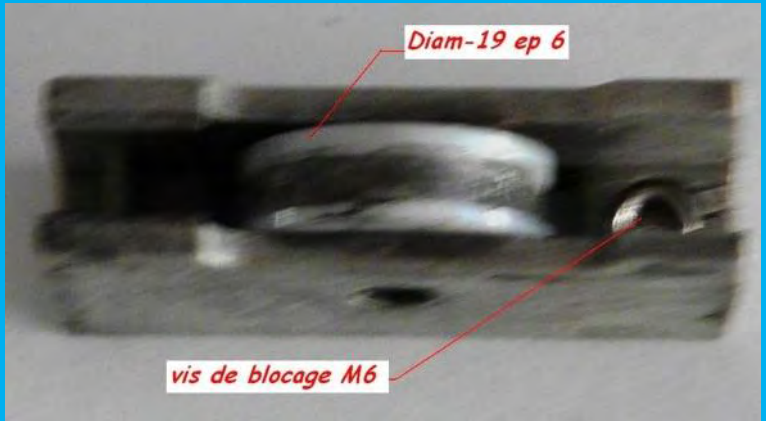
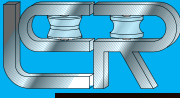

AC195

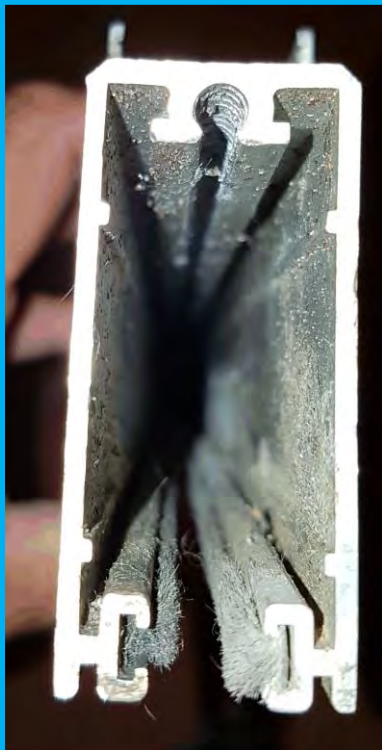
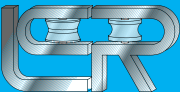

AC196

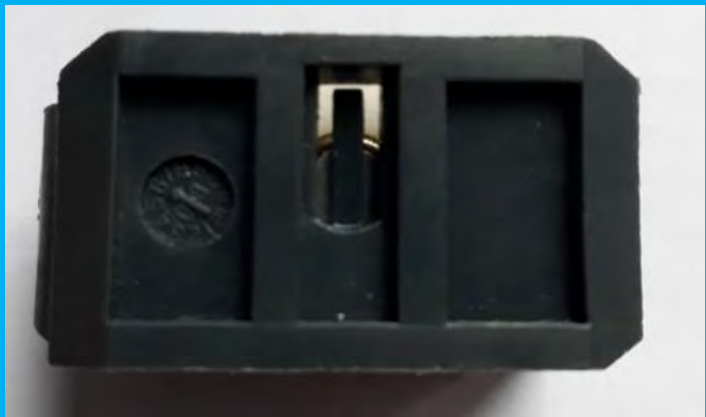

Disponible en original : 6168



AC197

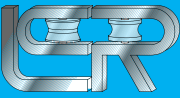

AC198

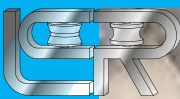

AC199

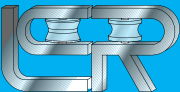

AC200

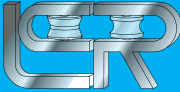

AC201

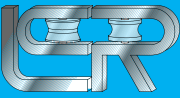

AC202

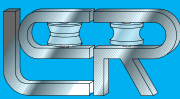

AC203

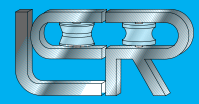

21 x 26



AC204

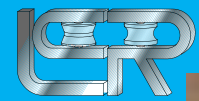

AC205

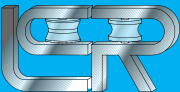

✓Code Chariot : 219 272 01



AC206

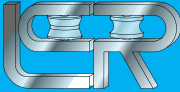

AC207

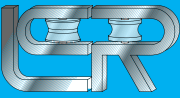

AC208

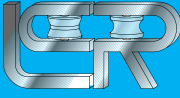

AC209

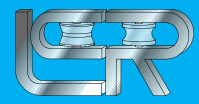

L : 20,6 H : 21,4



AC210

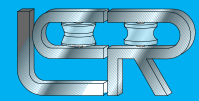

AC211

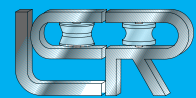

L : 30 H : 41

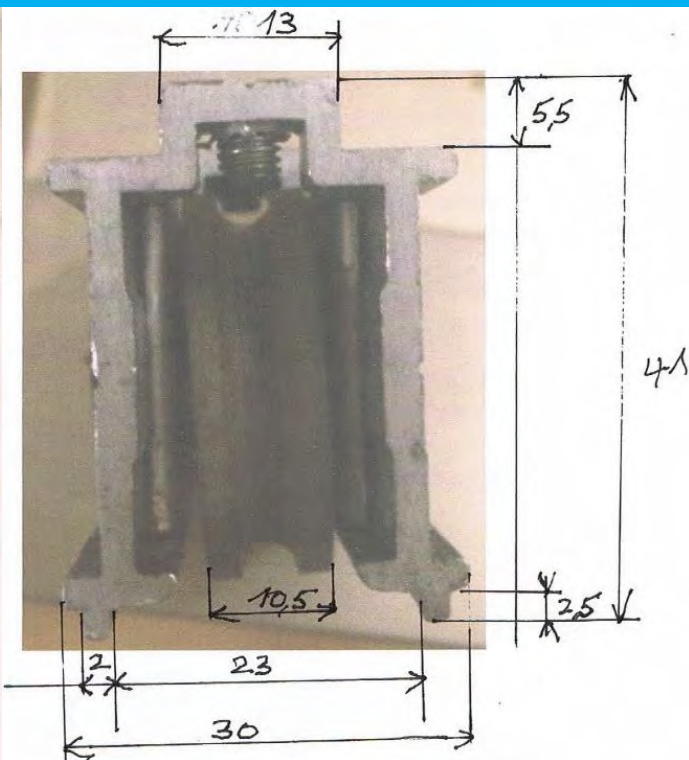
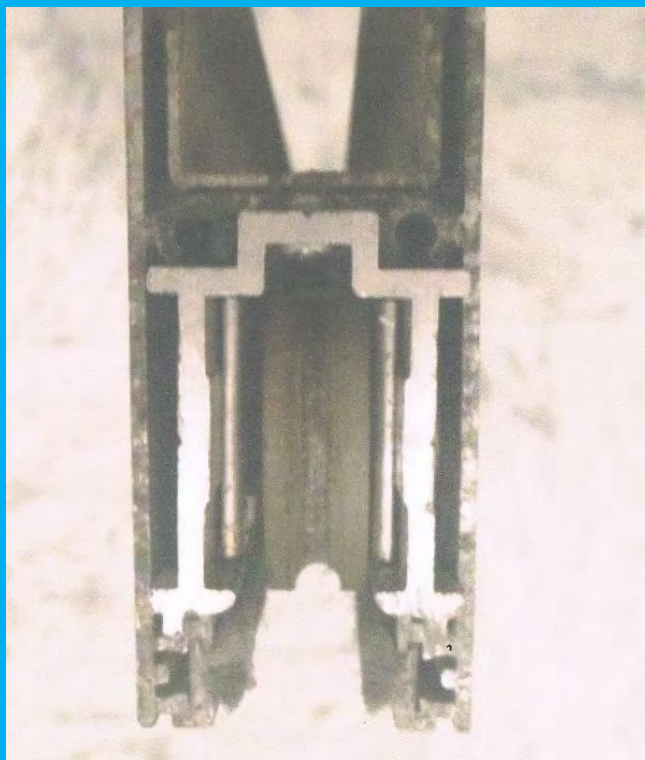

AC212

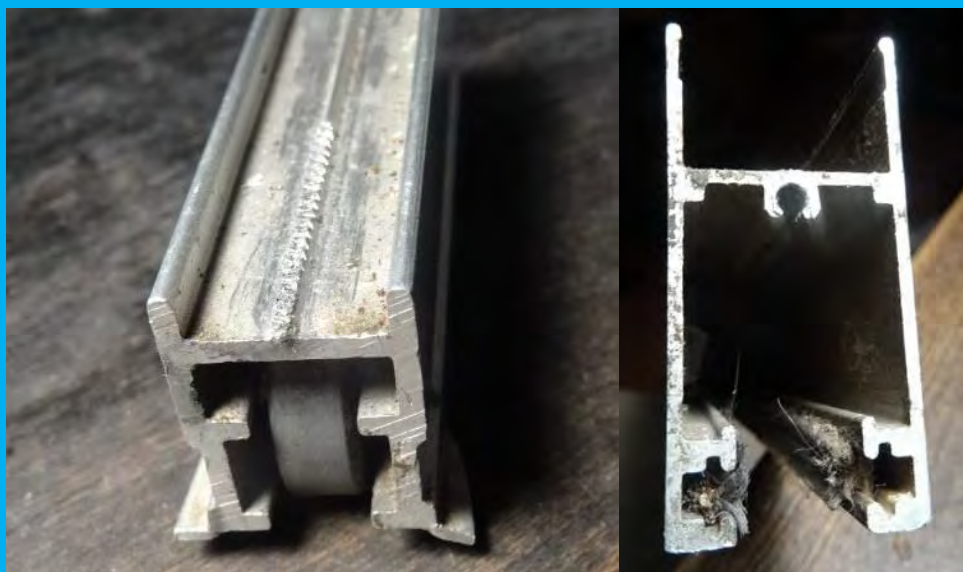

AC213

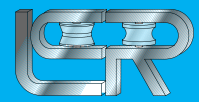

✓Code Cage : Z0209



AC214

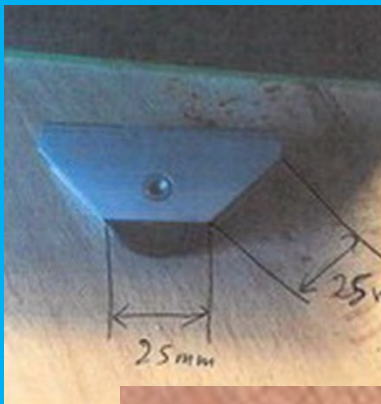
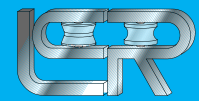

AC215

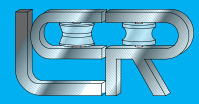

AC216

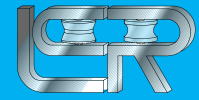

AC217

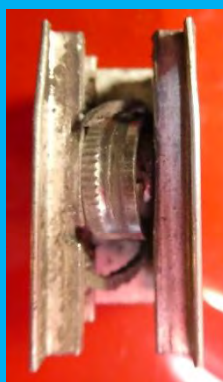
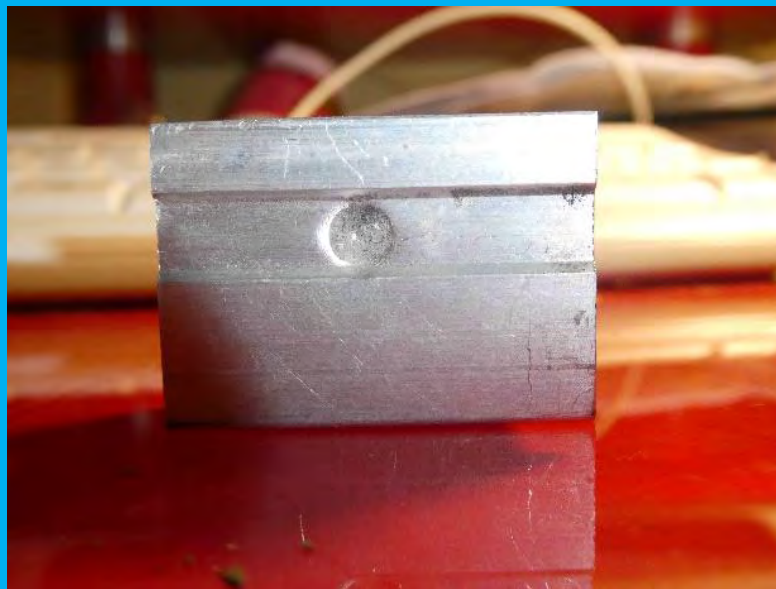
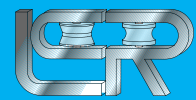

AC218



Disponible en original : 6919

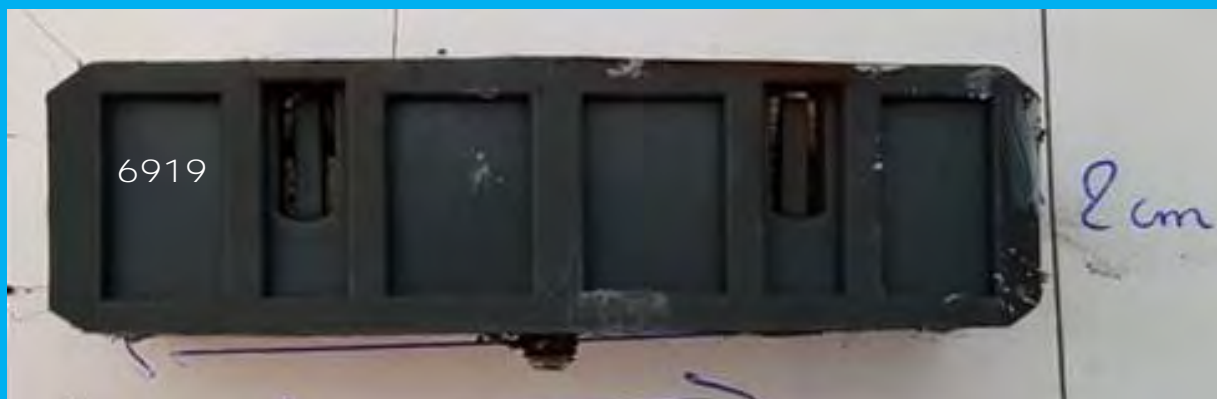
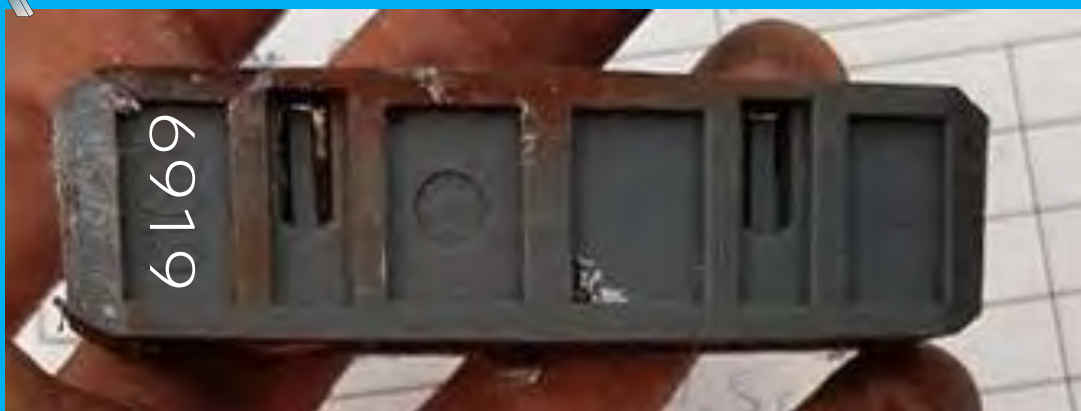

AC219

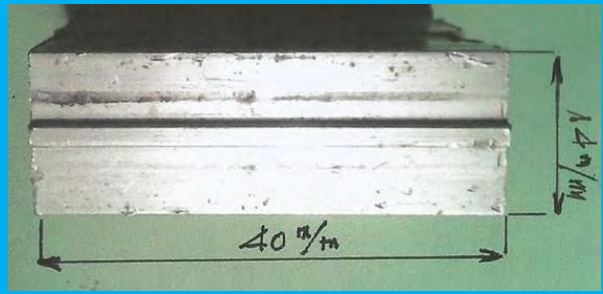
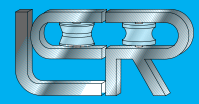

AC220

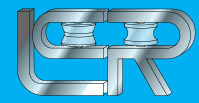

AC221

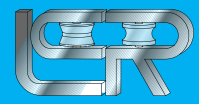

AC222

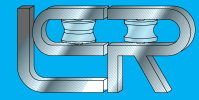

AC223

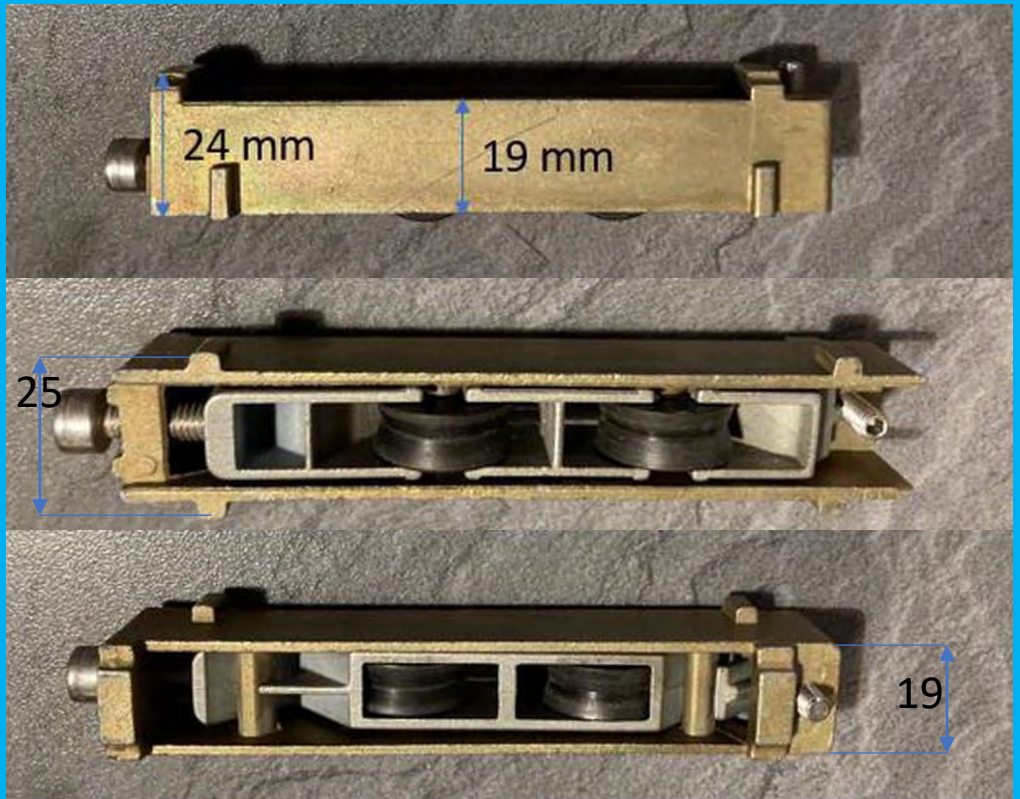
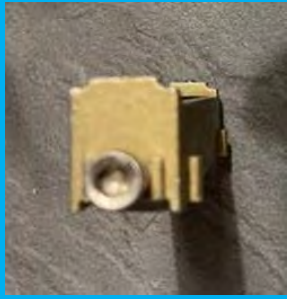
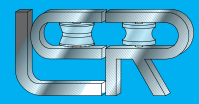

L : 25 H : 24

AC224

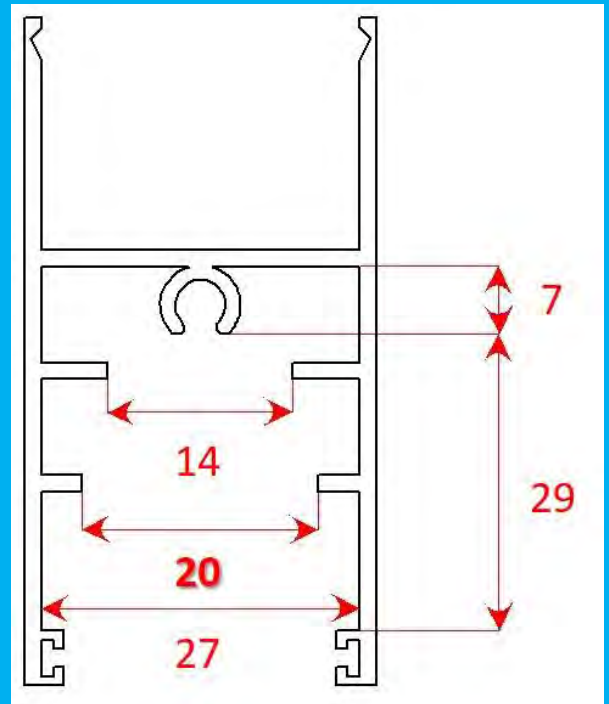

AC225

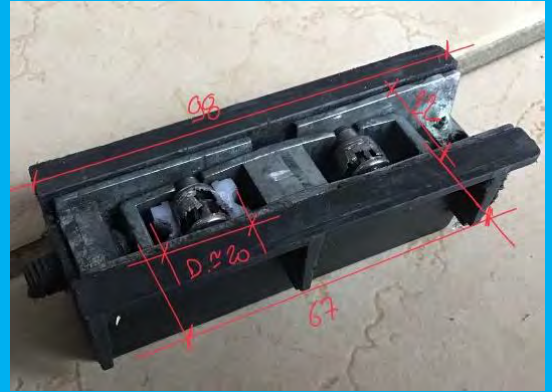
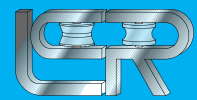

AC226

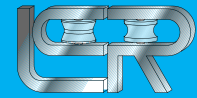

Code sur chariot : 88A01
88A04

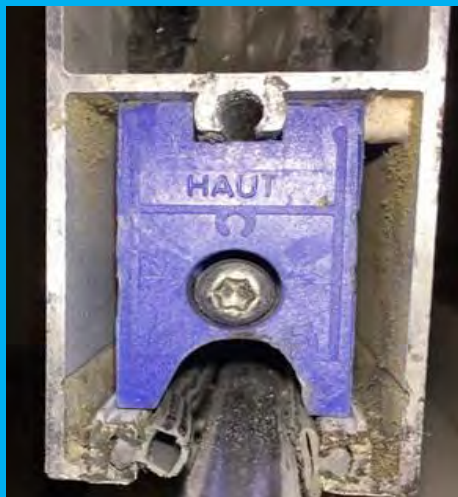

AC227

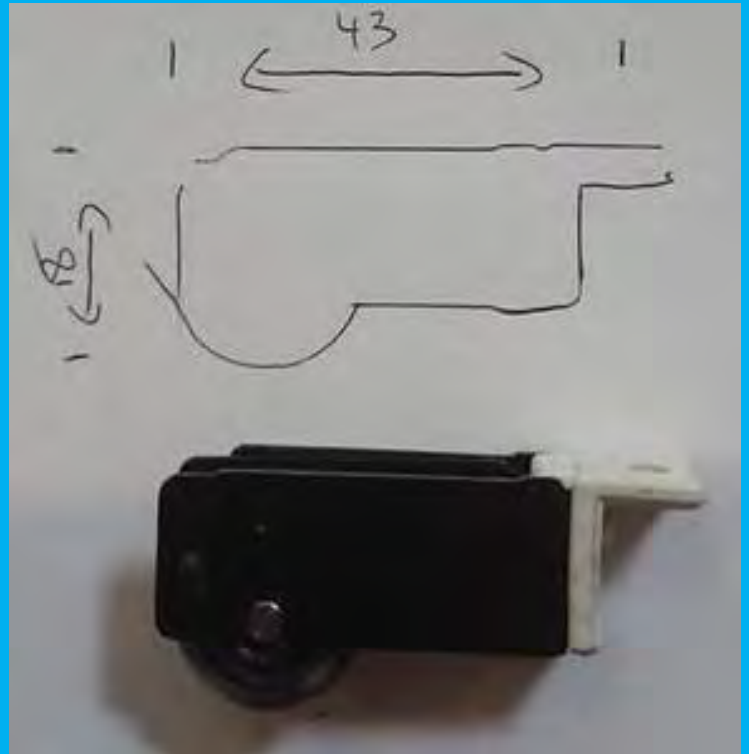
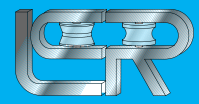

AC228

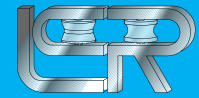

AC229

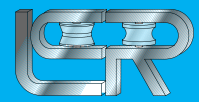

✓DGR622876 ROTO

✓AMIG 27182-R3

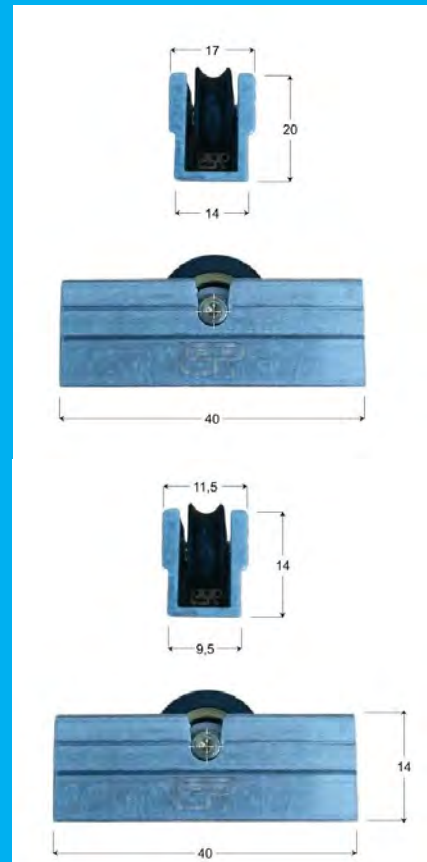

AC230

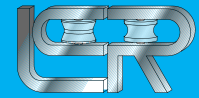

AC231

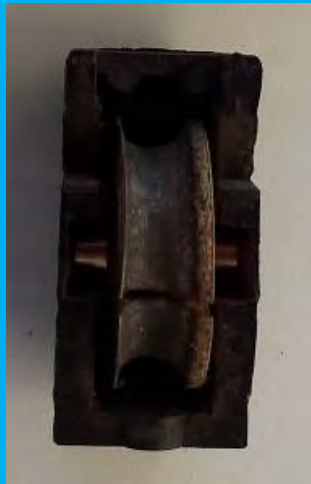
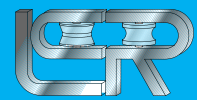

✓Code Chariot : 4401A

✓Code Cage : 4400CG/150°/R3



AC232



✓Codes Chariot : SR-S03

SR002L



AC233

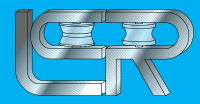

AC234

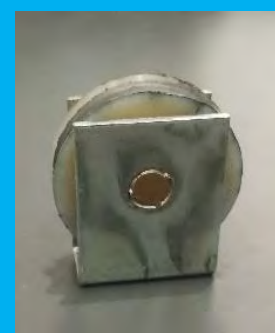
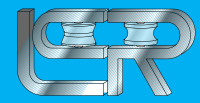

AC235

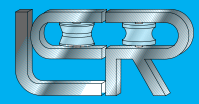

AC236

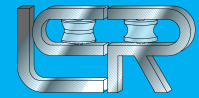

REEMPLACER
LA CAGE



AC237

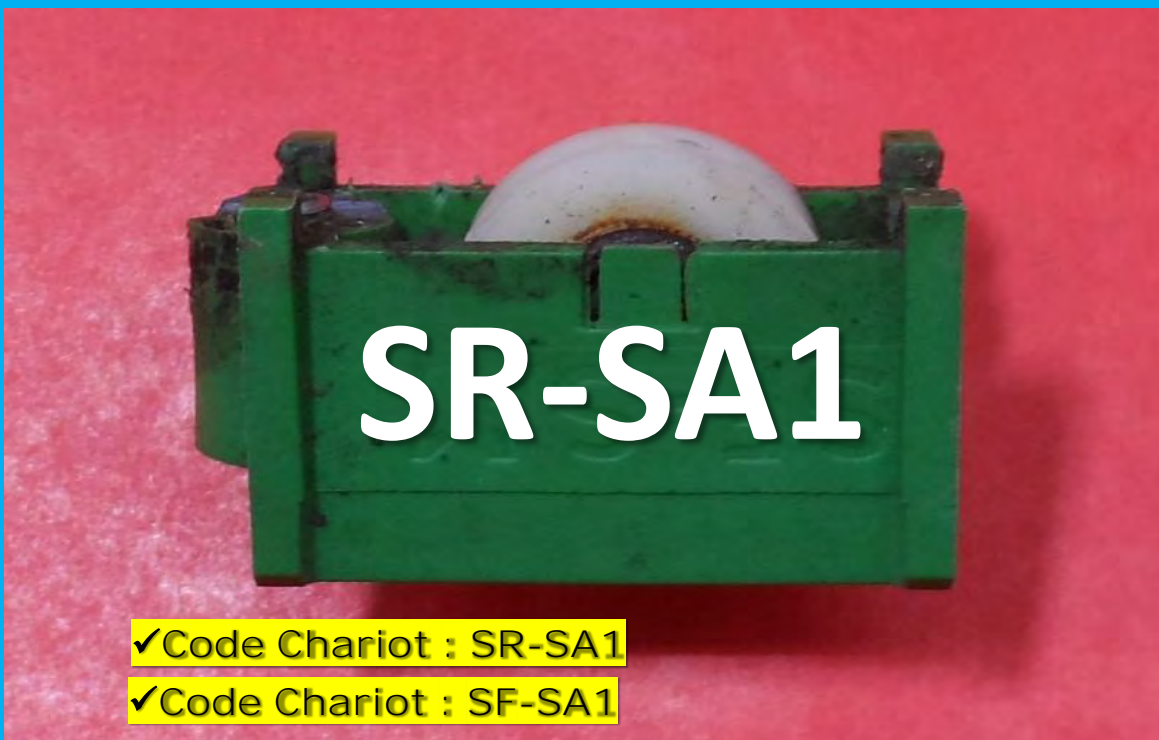

AC238

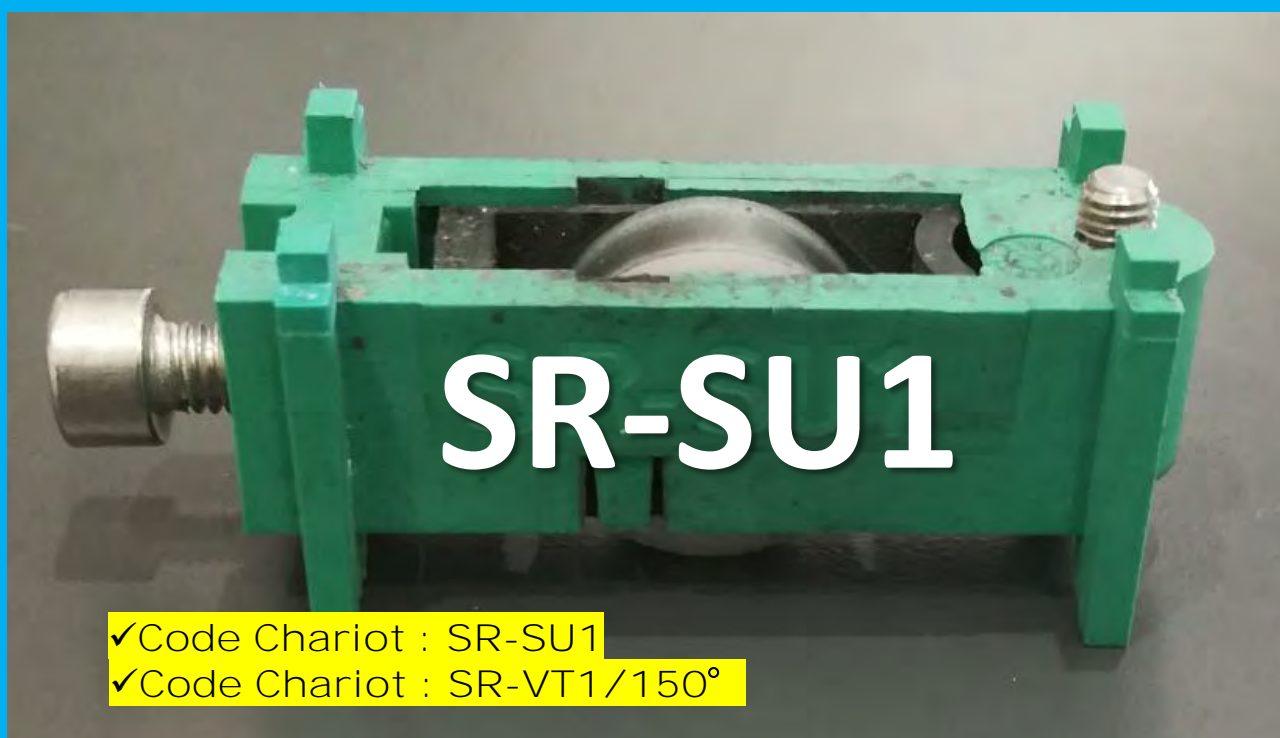

AC239

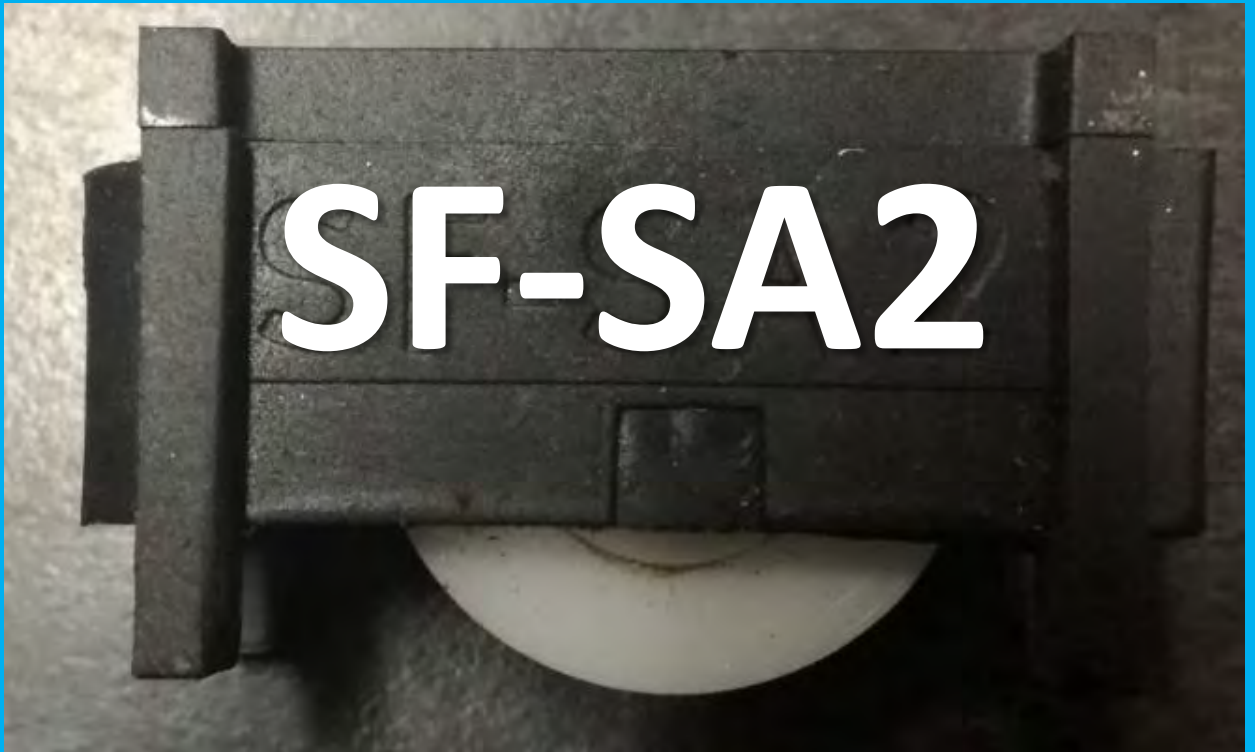
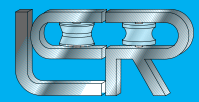

AC240

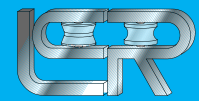

AC241

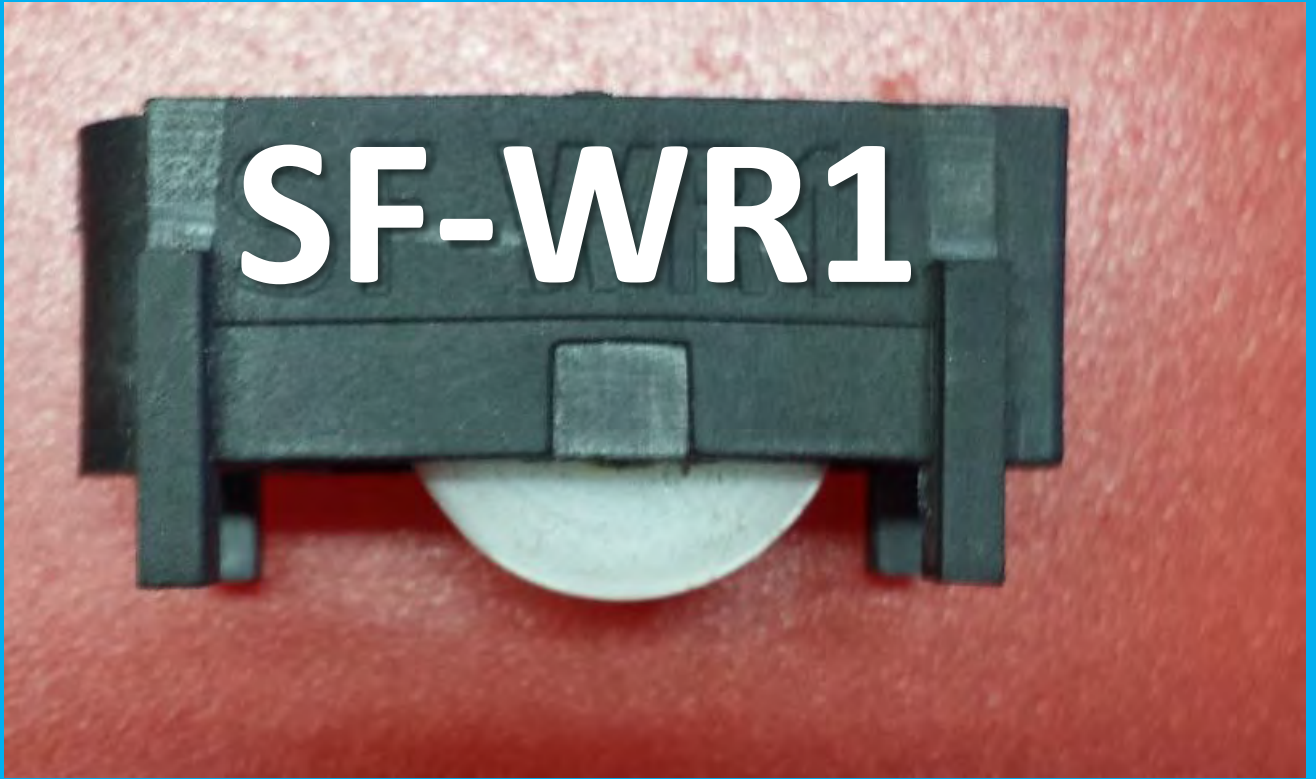
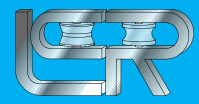

AC242

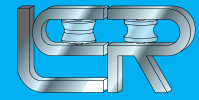

AC243

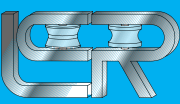

AC244

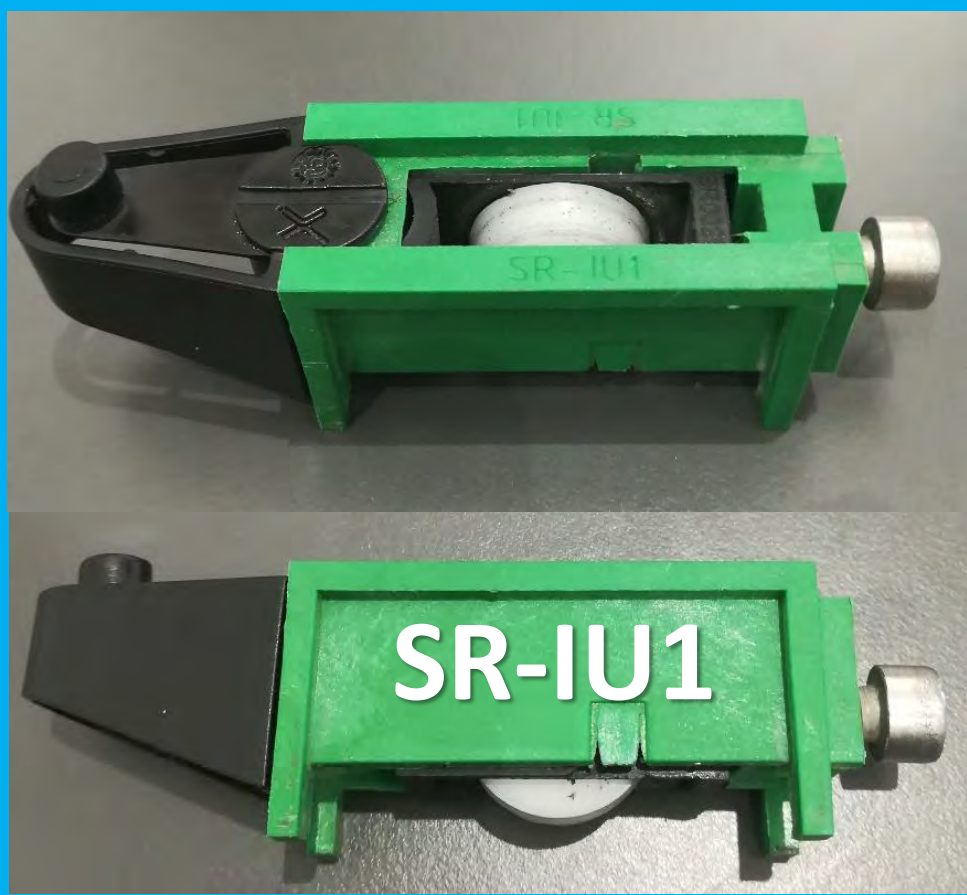
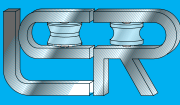

AC245

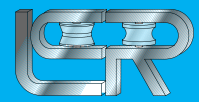

AC246

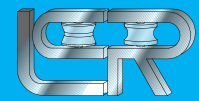

AC247

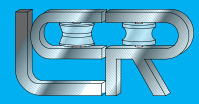

AC248

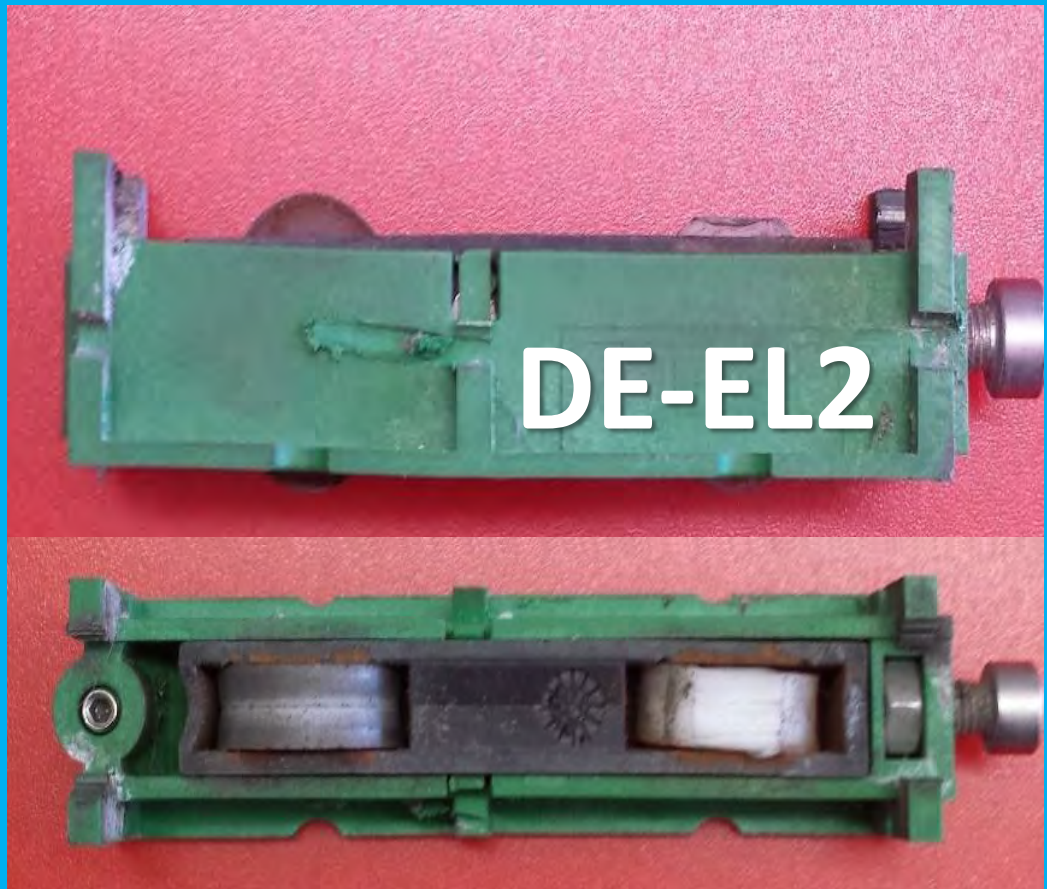
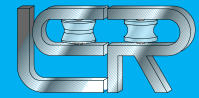

AC249

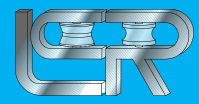

AC250

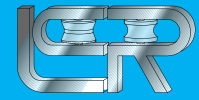

AC251

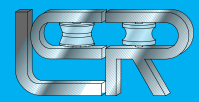

AC252

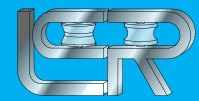

AC253

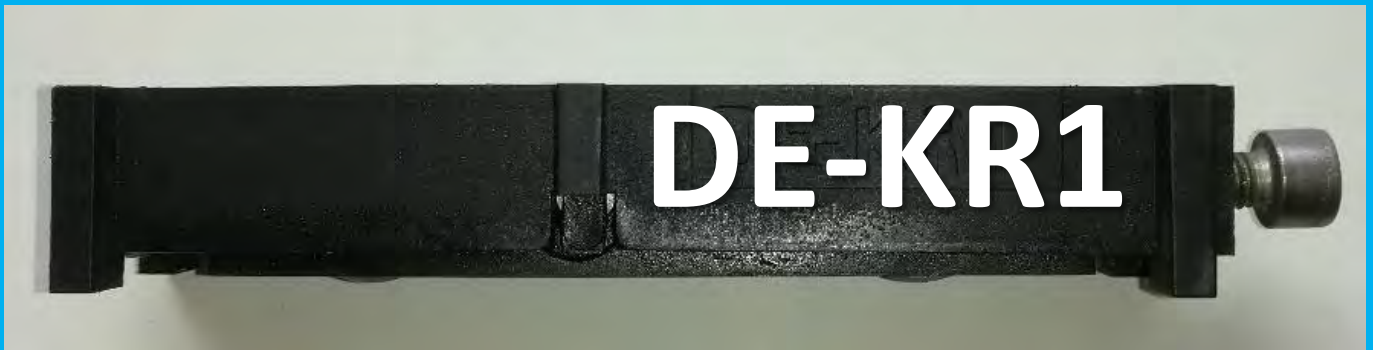
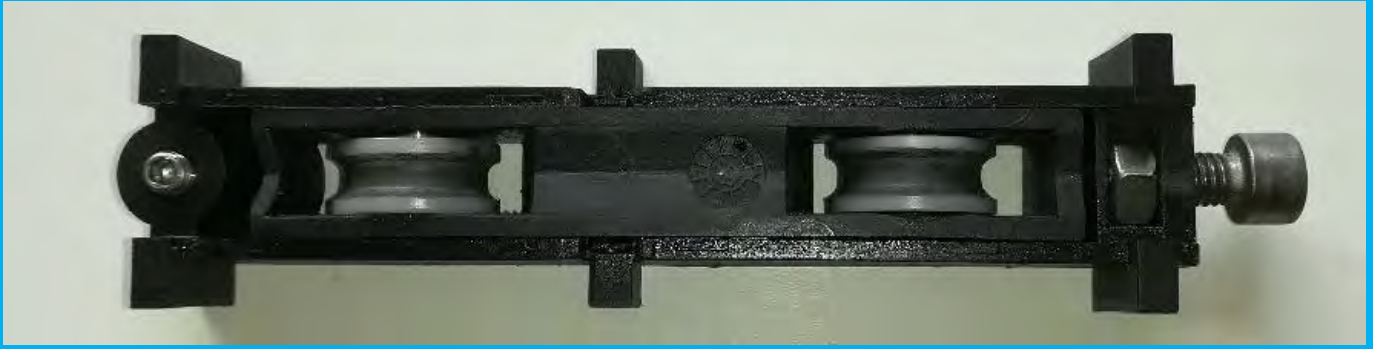
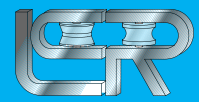

AC254

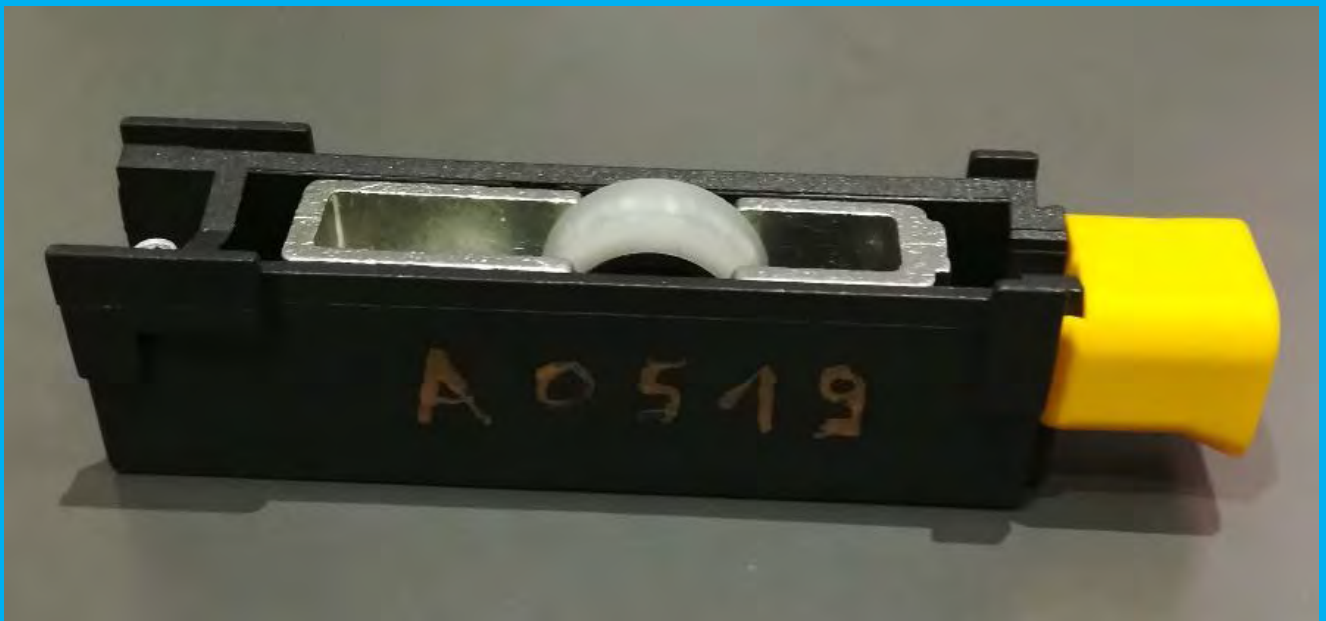
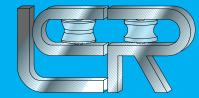

- ✓Code cage simple **E5161**
- ✓Code chariot **A0519**

AC255

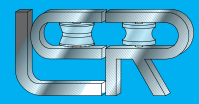

AC256

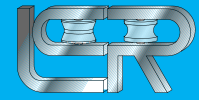

AC257

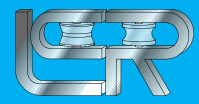

AC258

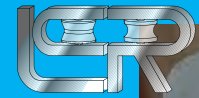

AC259

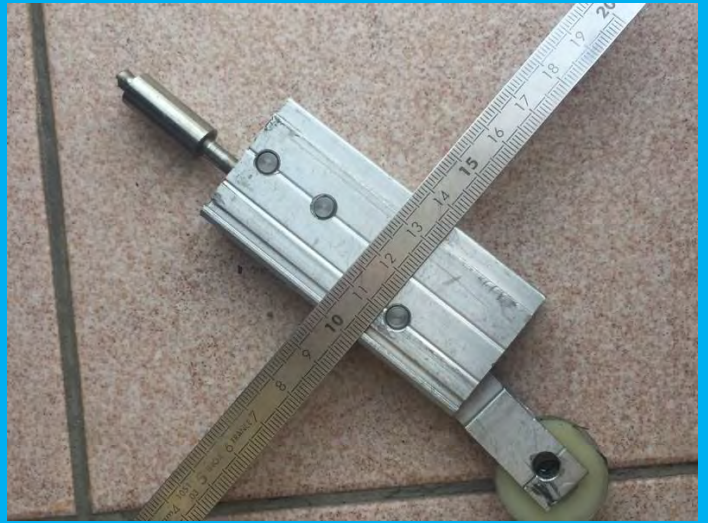
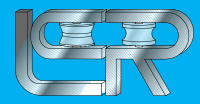

AC260

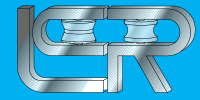

AC261

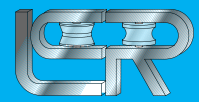

AC262

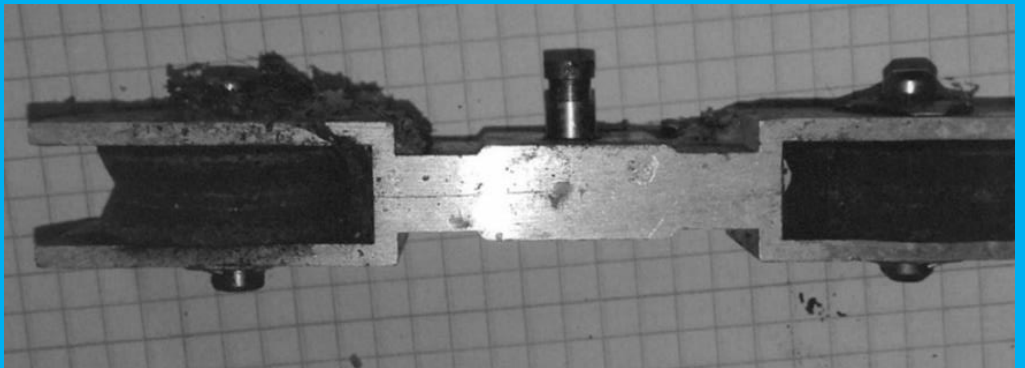
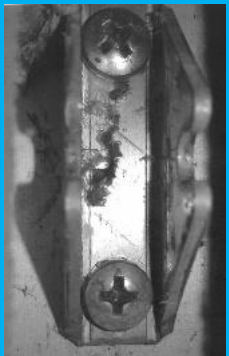
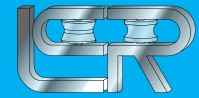

AC263

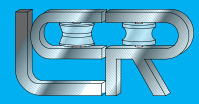

AC264

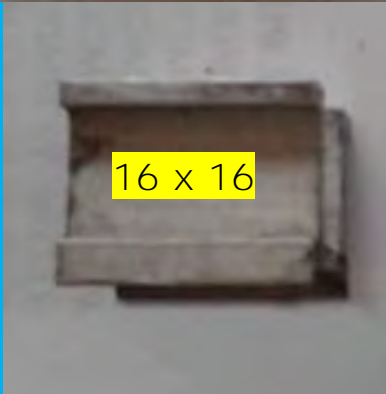
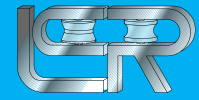

AC265

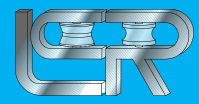

L: 8 H: 9

AC266

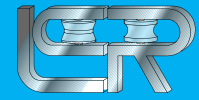

AC267

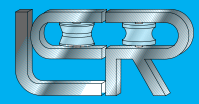

AC268

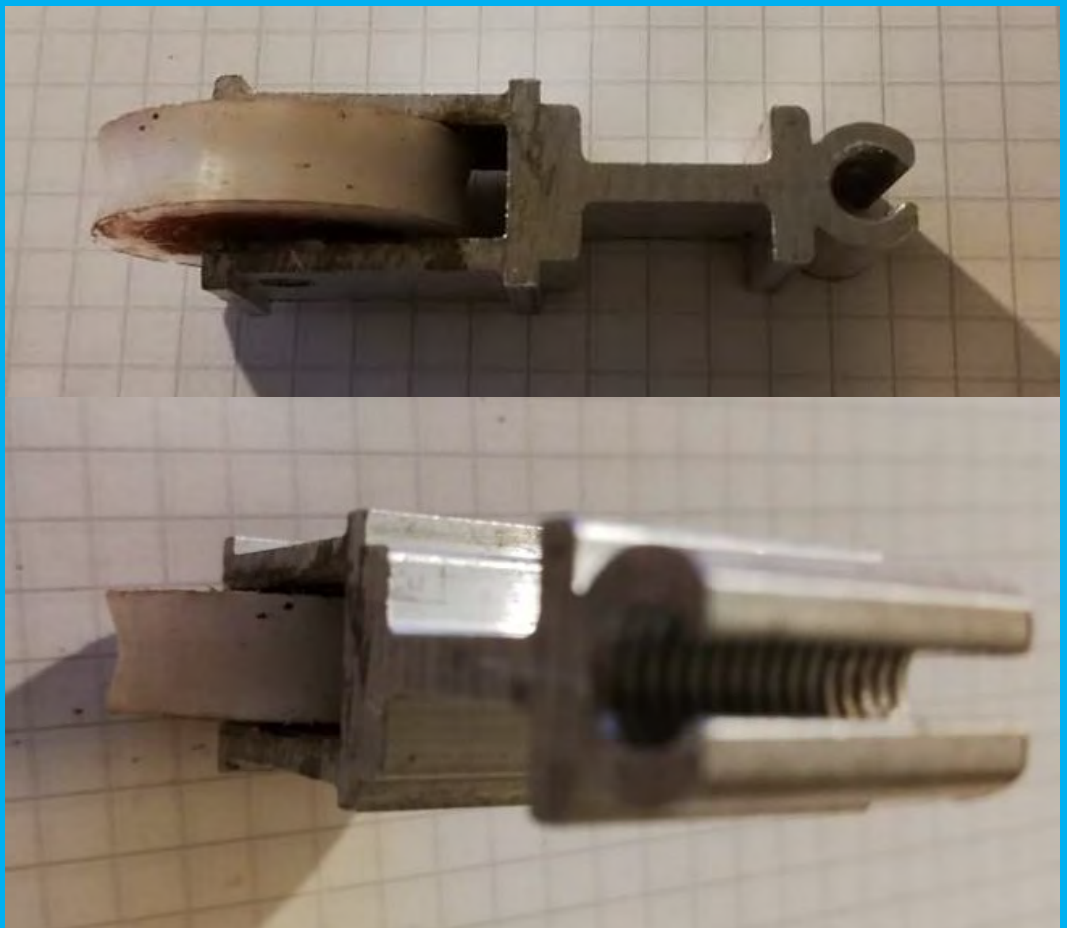
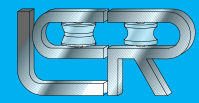

AC269

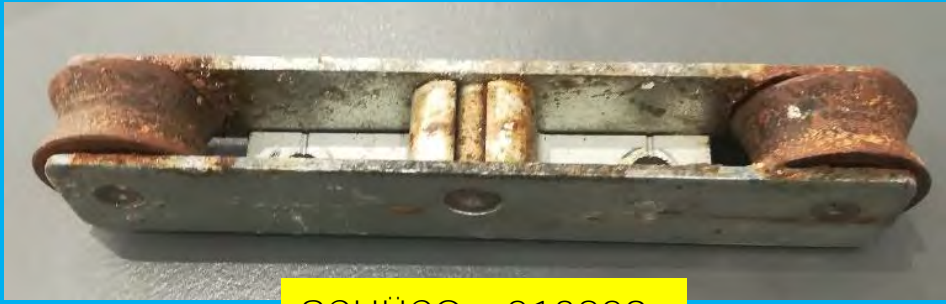
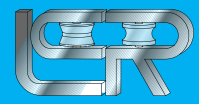

SCHÜCO : 213829

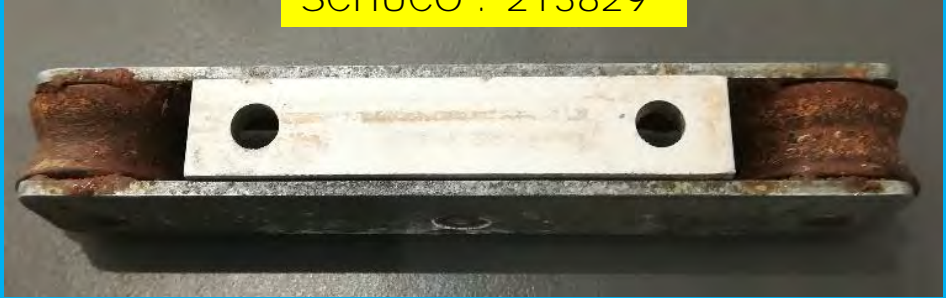

L : 17 H : 20

AC270

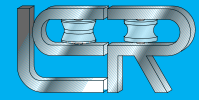

Disponibile en K-LINE : 20390

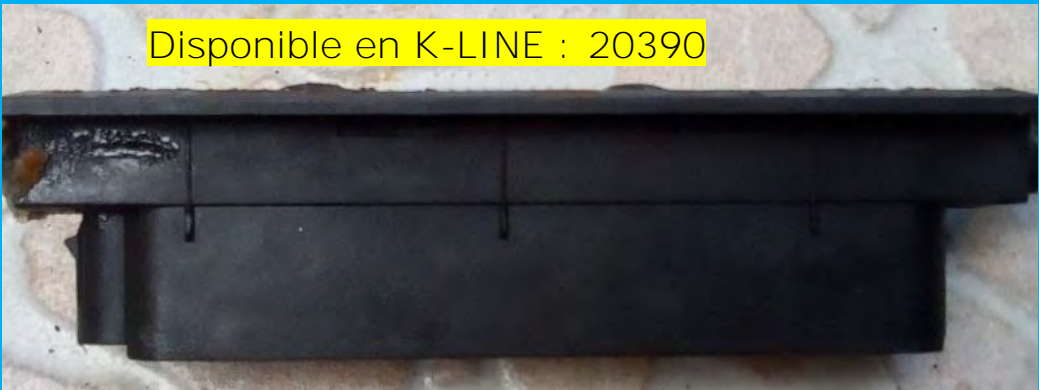

AC271

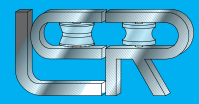

AC272

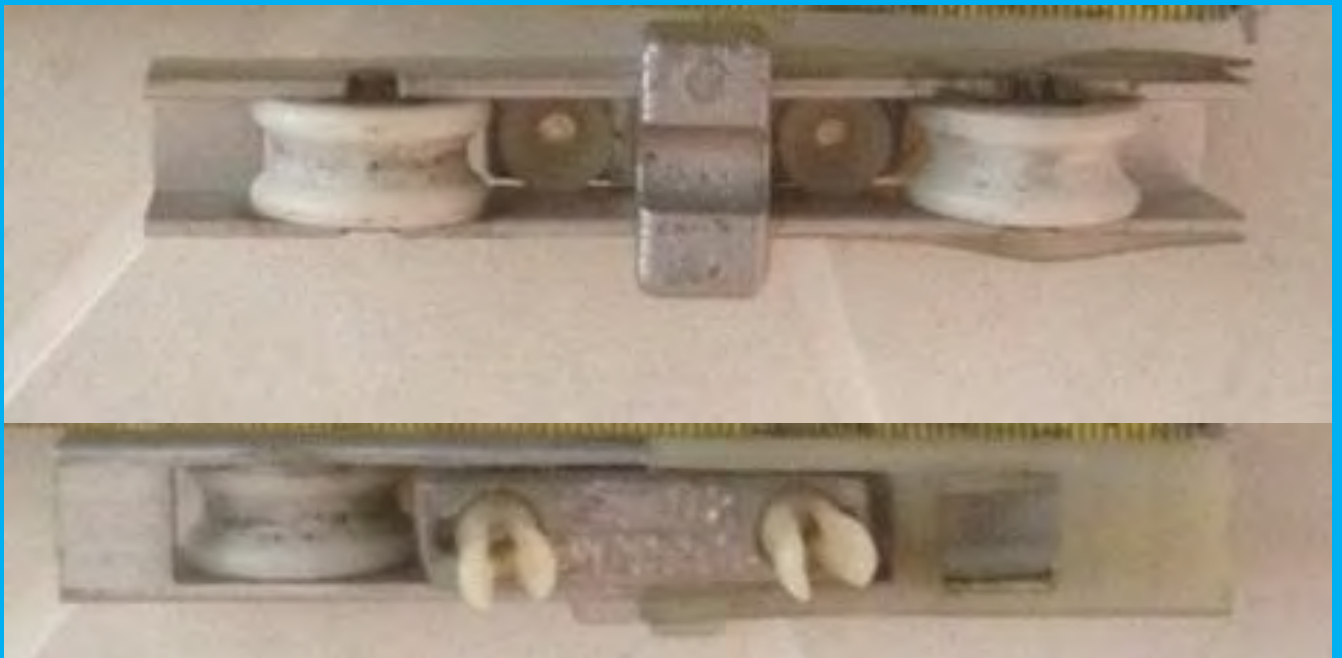
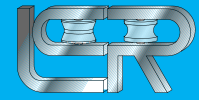

AC273

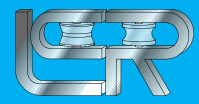

AC274

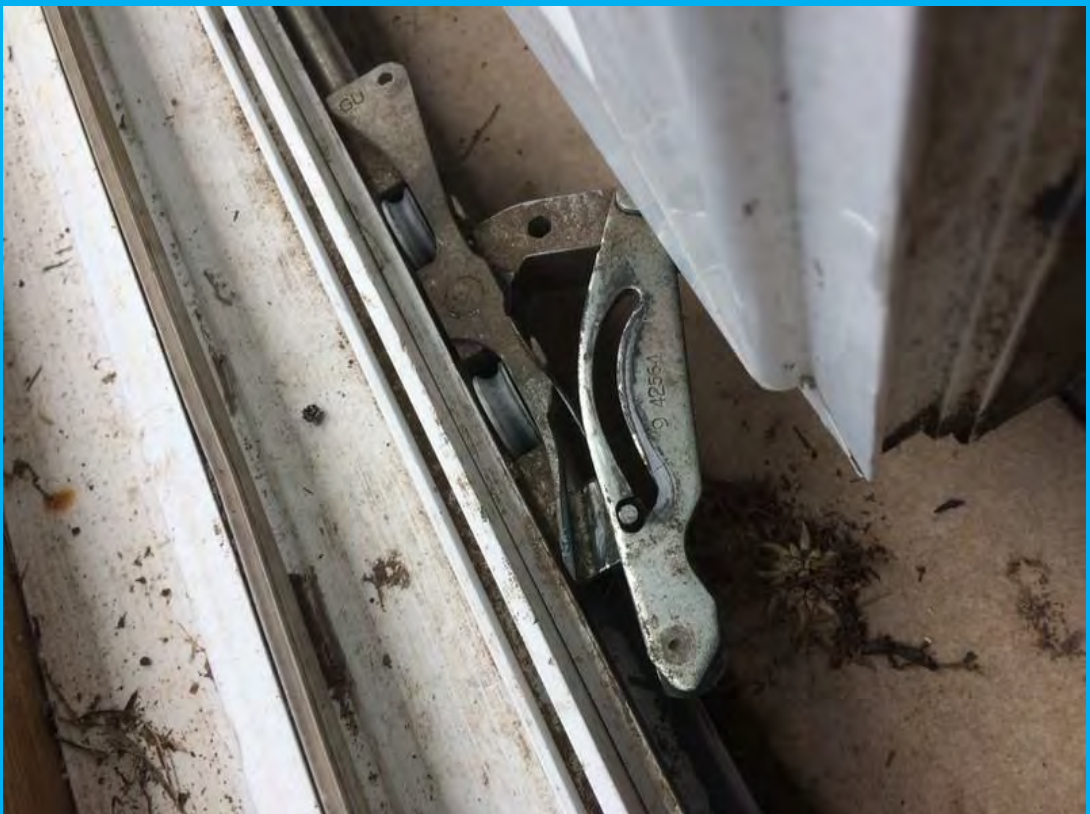
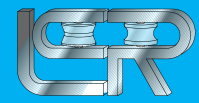

AC275

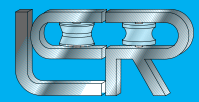

AC276

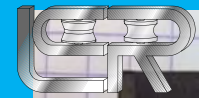

AC277

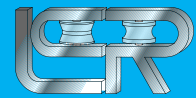

L : 20 H : 30

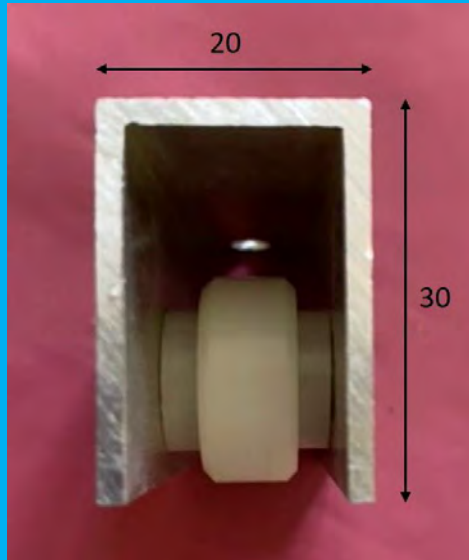

AC278



L : 25 H : 24



AC279

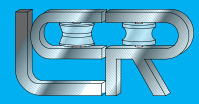

L : 14 H : 20



AC280

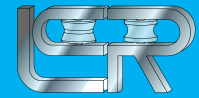

L : 31 H : 24



✓ DGR4218-150°

